

Portable Automatic Gas Cutter



BCG00B02

IK-12 NEXT

OPERATION MANUAL



For every person who will be engaged in operation and maintenance supervision, It is recommended to read through this manual before any operations, so as to permit optimum operation of this machine.

KOIKE SANZO KOGYO CO.,LTD.

INTRODUCTION

Thank you very much for purchasing this product. Read this instruction manual thoroughly to ensure correct, safe and effective use of the machine.

Read the manual first to understand how to operate and maintain the machine.

Cooperation between colleagues in the workplace is essential for safe, smooth operation. Make sure you read, understand and take all necessary safety precautions.

SAFETY PRECAUTIONS









This product is designed to be safe, but it can cause serious accidents if not operated correctly. Those who operate and repair this machine must read this manual thoroughly before operating, inspecting and maintaining the machine. Keep the manual near the machine so that anyone operates the machine can refer to it as necessary.

- Do not use the machine carelessly without following the instructions in the manual.
- Use the machine only after you have completely understood the contents of the manual.
- If an explanation in the manual is difficult to understand, contact our company or sales service office.
- Keep the manual to hand at all times and read it as many times as is necessary for a complete understanding.
- If the manual becomes lost or damaged, place an order with our company or sales service office for a new one.
- When transferring the machine to a new owner, be sure to hand over this instruction manual as well.

QUALIFICATIONS FOR MACHINE OPERATOR

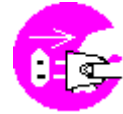
Operators and repair staff of this machine must completely understand the contents of the instruction manual and have either of the following qualifications:

1. Gas welding foremen's license
2. Completion of gas welding training course
3. Approval by the Minister of Labor

Symbol	Title	Meaning
	General	General caution, warning, and danger.
	Be careful not to get your fingers caught.	Possible injury to fingers if caught in the insertion port.
	Caution: Electric shock!	Possible electric shock under special conditions.
	Ground this equipment.	Operators must ground the equipment using the safety grounding terminal.
	Pull out the power plug from the outlet.	Operators must unplug the power plug from the outlet when a failure occurs or when there is a danger of lightning damage.
	Caution against bursting	Possible bursting under certain conditions.
	General	General warning.
	Caution: Hot!	Possible injury due to high temperature under certain conditions.
	Caution: Ignition!	Possible ignition under certain conditions.

CONTENTS

1.	Safety information -----	1
1.1	General machine safety precautions -----	1
1.2	Gus cutting safety precautions -----	3
1.3	Plasma cutting safety precautions -----	5
1.4	Welding safety precautions -----	11
2.	Location of Safety labels -----	16
3.	Overview of the Unit -----	17
3.1	Features of the Unit -----	17
3.2	Specifications -----	18
3.3	Contents of package -----	18
4.	Method of operation -----	19
4.1	Name of each parts -----	20
4.2	Operation panel -----	22
5.	Gas cutting operation -----	35
5.1	Standard composition of gas equipment -----	35
5.2	Assembling the Unit (for a Single Torch Set) -----	36
5.3	Preparation for Work -----	36
5.4	Safety Measures before Starting Work -----	37
5.5	Ignition and flame adjustment -----	38
5.6	Cutting and piercing method -----	38
5.7	Procedures for starting cutting operation and extinguishing the flame -----	38
5.8	Safety measures against backfire and flashback -----	39
5.9	Cutting operation -----	39
6.	Plasma cutting operation -----	41
6.1	Preparation for Work -----	41
6.2	Cutting operation -----	41
7.	Welding Work -----	41
7.1	Preparation for Work -----	41
7.2	Welding Work -----	42
8.	Maintenance Inspections -----	42
8.1	Daily Inspections -----	42
8.2	Monthly Inspections -----	42
8.3	3-monthly Inspections -----	42
8.4	About the Warranty -----	42
9.	Trouble shooting -----	43
10.	Wiring Diagram -----	46
11.	Assembly drawing of IK-12 NEXT -----	47
12.	Parts list -----	48
12.1	Main body and inside parts -----	48
12.2	Outside parts -----	50
12.3	Electrical parts -----	52
13.	Cutting Data -----	54

1 Safety information

Many accidents are caused by operation, inspection, and maintenance which disregard the basic safety rules. Carefully read, understand, and master the safety measures and precautions described in this instruction manual and on the machine before operating, inspecting and maintaining the machine.

The safety messages are classified as follows for machine safety labels:

■ DANGER



Improper handling is very likely to cause death or serious injury.

■ WARNING



This word is used in a warning message and a warning label at places that could cause injury or serious accident.

■ CAUTION



This word is used in a caution message and a caution label at places that could cause slight injury or machine damage. This is also used as a caution for frequent dangerous actions.

■ NOTICE SIGNS



This is a sign to show machine operators and maintenance engineers items that relate directly to damage of machines and surrounding facilities and equipment.

1.1 General machine safety precautions

Read and fully understand the following important safety information:

1.1.1 Machine safety

1. The machine casing is mainly made of aluminum alloy to reduce weight. For this reason, be careful not to drop a heavy item on the machine, or not drop the machine when carrying it since the alloy is not designed to withstand such impact.
2. When mounting hoses to the torch and distributor, tighten the nut with the wrench. After mounting, be sure to check there is no gas leak with a detection liquid. If a gas leak is found, retighten the nut firmly.
3. When fixing a tip to the torch, tighten the nut with the two wrenches. In addition, avoid damaging the taper of the tip since this may cause backfire.
4. Never disassemble the machine other than during maintenance and inspection. Otherwise, malfunction will result.
5. Never remodel the machine. Remodeling is very dangerous.
6. When changing the direction, make sure that the direction switch is in the neutral (stop) position, and operate the direction switch after the machine has stopped.
7. Always turn the power off when not in use.
8. Never use the machine outdoors when the weather is wet. This will cause failure of the machine and could cause a fatal accident by electric shock.

1.1.2 Safety clothing

1. Be sure to wear protectors gauntlets, goggles, helmet, and safety shoes during operation.
2. Avoid operating the machine with wet clothes or hands in order to prevent electric shock.

1.1.3 Operation and handling safety precautions

1. Read this instruction manual before operating the machine.
2. Mount and center the machine correctly and confirm correct motion before operation.
3. Before connecting the power plug to the outlet, make sure that the power switch is in the OFF position (or the normal / reverse changeover switch is in the stop position).
4. Prior to operating the machine, check the safety of the surroundings to avoid accidents.
5. Never move the machine while the preheat flame is on.
6. Take great care of spatters and dross when operating the machine at a high position. They may injure people below.
7. Make sure that the clutch is engaged before letting the machine travel. Improper clutch engagement will cause machine failure.
- 8. Be careful not to get you hand caught between rails when connecting them.**
9. When cutting on the rail, correctly fix the caster.
10. Correctly fix the heat prevention plate so that it will not touch the rail.
11. To prevent the torch holder from dropping, fix it with the wing bolt (BS-6x22) on the torch slide.
12. Be sure to hold the handle when carrying the machine.
13. Be sure to remove the machine from the rail when moving the rail.

1.1.4 Electrical system precautions



1. Be sure to check the input power voltage of the machine before operation. The input power voltage should be in the range of $\pm 10\%$ of the rated voltage. The machine should not be operated out of this range.
2. The metal plugs are screw-threaded, therefore, fully tighten them so that they will not come loose during operation.
3. The ground pin is attached to the rubber plug of a cabtyre cord. Please use a power receptacle with a ground pin opening.
- 4. Stop operation and turn off the power in the following cases, and ask a qualified electrician to repair the machine.** 
- 1) Broken or abraded cables
- 2) Water leakage from the machine or liquid damage to the machine
- 3) Abnormal machine operation despite operating the machine according to the instruction manual
- 4) Machine breakdown
- 5) Poor machine performance that requires repair
5. Periodically inspect the electrical system.

1.1.5 Maintenance and inspection precautions



1. Ask a qualified electrician to perform repair and inspection service.
2. Disconnect the power plug before inspecting and repairing the machine.
3. Maintain the machine periodically.

1.1.6 About the transport of the machine

1. Be sure to hold the handle when carrying the machine.
2. Be sure to remove the machine from the rail when moving the rail.
3. Do not lift the carriage by holding its Handle. There is risk of falling off carriage while holding carriage by handle, if there is shockimpact at carriage or if mounting screw of handle is loose.

1.1.7 Machine noise

1. Volume of at the time of driving the machine is less than 70dB.

1.1.8 About external environment

1. Never use the machine outdoors when the weather is wet. This will cause failure of the machine and could cause a fatal accident by electric shock.
2. Please avoid high temperature and humidity.
3. Please use in an environment where the internal temperature is 5 ~ 70 °C.
4. Please use in an environment with internal humidity of 20 to 80% RH.

1.2 Gas cutting safety precautions

Strictly observe the safety rules and precautions to ensure the safety of gas cutting operations. Operators and supervisors MUST keep safety in mind.

1.2.1 Prevention of explosion



1. Never cut pressurized cylinders or hermetically sealed containers.
2. Ensure sufficient ventilation for gas cutting to prevent the air from becoming stale.

1.2.2 Pressure regulator safety precautions.



1. Before starting operation, check that all pressure regulators are operating correctly.
2. Ask a skilled repair engineer to perform maintenance and inspection service.
3. Do not use pressure regulators from which gas is leaking, nor malfunctioning pressure regulators.
4. Do not use pressure regulators smeared with oil or grease.

1.2.3 High-pressure gas cylinder safety precautions



1. Never use broken cylinders or cylinders from which gas is leaking
 2. Install cylinders upright and take measures to prevent them from falling.
 3. Use cylinders only for specified purposes.
 4. Do not smear container valves with oil or grease.
 5. Install cylinders in a place free from heat, sparks, slag, and naked flame.
 6. Contact the distributor if the container valves will not open.
- Never use a hammer, wrench, or other tools to forcibly open container valves.

1.2.4 Safety precautions for hoses



1. Use the oxygen hose for oxygen gas only.
2. Replace cracked hoses or other hoses damaged by sparks, heat, unshielded fire, etc.
3. Install hoses without twisting.
4. To prevent breakage of hoses, take great care during operation and transportation.
5. Do not hold the hoses when moving the machine.
6. Periodically check the hoses for damage, leakage, fatigue, loose joints, etc, to ensure safety.
7. Cut hoses to the minimum possible length. Short hoses reduce hose damage and pressure drop, as well as reduce the flow resistance.

1.2.5 Safety precautions for fire



Take safety precautions to prevent fire prior to gas cutting. Ignoring hot metal, sparks, and slag could cause a fire.

1. Keep a fire extinguisher, fire extinguishing sand, bucket full of water, etc. ready on the site where gas cutting is performed.
2. Keep flammables away from the cutting area to avoid exposure to sparks.
3. Always cool steel plates that have become hot after cutting, as well as hot cut parts or scrap, before bringing them close to flammables.
4. Never cut containers to which flammable materials are stuck.



1.2.6 Safety precautions for skin burns

Observe the safety precautions to prevent skin burns. Ignoring heat, spatter, and sparks during operation could cause a fire or burned skin.

1. Do not perform cutting near flammables. (Move flammables well away from the sparks.)
2. Do not cut containers filled with flammables.
3. Do not keep lighters, matches, and other flammables nearby.
4. Flames from the torch will burn skin. Keep your body away from the torch and tip, and check the safety before operating the switches and valves.
5. Wear the correct protectors to protect your eyes and body.
6. Correctly tighten the tip to prevent backfire.
 - When fixing a tip to the torch, tighten the nut with the two wrenches .
 - If the tip is tightened excessively, it will be heated during cutting and tightened still more, making it difficult to remove the tip.
 - Avoid damaging the taper of the tip since this may cause backfire.
7. Check with soapsuds for any leakage of gas from the connection part of the distributor, hose, and torch.

Never use oil or grease on the connection of the oxygen pipe to avoid backfire which may lead to explosion.
8. Be sure to check the following when igniting:
 - Place the torch on the torch holder before igniting.
 - Always wear the required protectors (gauntlets, goggles, helmet, etc.)
 - Check for any obstacles, dangerous materials and flammables near or in the direction of cutting. Determine the gas pressure.
 - The gas pressure must be within the appropriate range. (For the gas pressure, refer to the Cutting Data.)
9. The torch, tip, and heat shield are heated to a very high temperature. Always wear gauntlets when handling them. Also the surface after cutting is very hot so do not touch it even while wearing gauntlets.
10. Never move the machine while the preheat flame is on.

1.3 Plasma cutting safety precautions

In order to carry out plasma cutting safely, it is important to observe precautions and rules for safety, and to keep in mind safety as a daily practice. In plasma cutting, in particular, or damage the eye by an arc light, it burns due to high fever member will occur. Please wear protective equipment on your eyes and body.



1.3.1 Eye safety

Please observe the following in order to prevent eye injury accident caused by strong ultraviolet rays, sparks, hot metal and burns of face.

1. Wear dark safety glasses, side shielded goggles, welding helmet.

We recommend a light-shielding degree of glasses, such as shown in the following table.

(JIS T8141-1980)

Arc current	Shading number
150 < AMP	No.11
150~250 AMP	No.12
250~400 AMP	No.13
400 > AMP	No.14

2. Replace damaged shading plate · broken glasses · goggles · helmet.
3. Please warn other people in the workplace to wear eyeglasses, goggles, helmets.
4. We recommend that you can install protective screens and curtains to reduce the reflection and transmission of ultraviolet rays.



1.3.2 Ear safety

Noise it may harm the hearing. Please wear ear protection.



1.3.3 Skin safety

Protect your skin and limbs from powerful ultraviolet rays, sputtering, slag and dross or from the parts immediately after cutting.

1. Please wear protective clothing.
2. Please wear long gloves, safety shoes, safety bar.
3. Cover all the exposed portion, please wear clothing to prevent burns
4. In order to prevent the entry of sparks and slag, without a folded pants, please wear working clothes equipped with a pocket with a flap.

- 5. When you press the start button will cause the pilot arc immediately. Be sure to separate the body from the torch and cut it.
- 6 .When touching the torch, wait until the surface of the torch cools and perform the work.

1.3.4 Burn prevention



Heat, sputter, sparks may cause fire, burns.

- 1. Please do not cut near combustibles.
- 2. Please do not cut containers filled with combustibles.
- 3. Please do not wear burnable products such as gas lighters and matches.

1.3.5 Hume and gas harmful



- 1. When working near the cutting torch, please protect especially from the neck to the top from the fume.
- 2. Please provide a ventilator to protect workers from fumes and gases discharged during arc cutting.
- 3. If ventilation is inadequate, please use an effective gas mask.

WARNING	
	<ul style="list-style-type: none"> ● When cutting a metal containing zinc, lead, cadmium, beryllium, or metal painted with this metal, work with a complete ventilation system, dust collection and smoke evacuation unit. ● If you work near the torch, wear a breathing apparatus or a helmet to which air is supplied.

1.3.6 Prevention of toxic fume



- Fumes generated during cutting is harmful. Please implement measures surely.
- 1. Ventilate the cutting work area adequately.
 - 2. Before you cut, all of chlorinated solvents from the cutting site carry-out or, please remove. Certain types of chlorinated solvents are exposed to ultraviolet rays and decompose and become highly toxic gas phosgene, which is extremely dangerous.

3. When cutting galvanized metal, wear a mask correctly and use a proper ventilator.
4. Container or the like that contains the substance that contains toxic substances Please do not cut.

1.3.7 Explosion fire accident prevention



If you cut a container that is under pressure, it may explode. Please be careful.

1. Do not cut in an atmosphere containing explosive dust and steam.
2. Do not cut off pressurized cylinders or sealed containers.

	<h1>WARNING</h1>
	<ul style="list-style-type: none"> ● The plasma system uses compressed gas. When using a compression device or a cylinder, please carry out the correct safety operation.

1.3.8 Fire prevention



In plasma cutting, high temperature metal, sparks and slag are generated, which may cause fire and burns. Please take the following preventive measure.

1. Please prepare fire extinguishers and things useful for extinguishing on the cutting site.
2. Please move the combustible material to a place at least 10 m away from the cutting place.
3. Always be sure to cool beforehand if you place a newly cut metal or heated metal near the combustible material.
4. Do not cut containers containing flammable substances with plasma.
5. If you want to cut with plasma system, the flammable gases and vapors, please ventilation. Never operate the plasma in an atmosphere containing high concentrations of dust, flammable gas, flammable liquid vapor.

1.3.9 How to use safely



1. For the plasma system, safety interlock design is done. Never perform a bypass circuit, short circuit, etc. on the safety interlock.
2. Driving with the cover removed involves other people in the accident. It also prevents the proper cooling effect of the equipment.
3. Please do not use anything other than genuine parts for the torch. It leads to overheating and other accidents.

1.3.10 Electric shock prevention

The plasma system uses high voltage when arcing occurs. Please be aware of the following points when operating.

1. Please dry your body and clothes.
2. Please do not stand or touch the wet floor when cutting the plasma.
3. Please pay sufficient attention to electric shock. Wear insulation gloves and boots as insulation measures, especially when you must operate in the wet condition or near it.
4. Be sure to install fuses and breakers on the primary power supply side.

If an electric shock accident or a dangerous condition occurs, it is recommended to install an emergency shutdown device so that the power supply can be cut off instantaneously.

5. Please regularly inspect cracks, cracks etc. of the cover for hoses and cables.

Exposure of wires may result in serious accident, please do not use absolutely damaged power cord.

If you discover damage to the cables, please replace it immediately.

6. Please inspect the torch lead regularly. If you see damaged parts such as fatigue and wear, please replace it immediately.

**1.3.11 Ground of cutting surface plate**

1. Make sure to connect the ground cable directly from the cutting member or securely to the cutting surface plate.
2. Please secure the ground securely and fix it in a way not loose connection.

1.3.12 Ground

1. Make sure the ground wire of the primary power supply is securely connected to the airframe or operation panel.
2. Make sure that the ground wire of the plasma power supply is properly connected.
3. Please tighten the earth wire firmly with bolt nut.

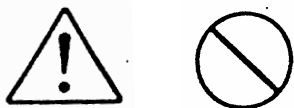
1.3.13 Hose

Please attach a display to distinguish the type of gas on the wall piping.

1. Do not use gas other than specified for each fluid hose.
2. Please replace the hose damaged by cracks, sparks, heat, naked fires etc.
3. Please be careful not to twist the hose.
4. To prevent damage to the hose, please laying in a safe condition on the outside of the passage so that there is no danger of tripping.
5. Please regularly check hose, leakage, fatigue, loose fitting etc.
6. In order to prevent damage to the hose, please keep the minimum length to prevent pressure drop and minimize the flow resistance.

1.3.14 Pressure regulator



1. Please use under the condition that all pressure regulators operate properly.
2. Defective regulator can rupture or cause serious accidents. By the skilled repair technician, repair, please check.
3. Never use pressure regulators that have leaks or malfunctions.
4. Do not use regulators with oil or grease.

1.3.15 Safety of plasma power supply and plasma torch



For handling of each plasma power supply and plasma torch, follow the contents of each instruction manual.

1.4 Welding safety precautions



WARNING

Strictly observe the following to prevent accidents resulting in serious injury or death.

- This welding machine is designed and manufactured by taking safety into consideration. However, never fail to observe the warning and precautions described in this instruction manual, otherwise accidents leading to serious injury or death can result.
- Keep people out of the space around the welding machine and working area.
- The welding machine generates a magnetic field around itself. Such a magnetic field affects certain types of sensors and clocks. For the same reason, any person who have a pacemaker in his heart shall not approach the welding machine in operation or the welding space unless he has obtained doctor's permission.
- For safety, leave the installation, maintenance, inspection, and repair of the machine to a person who has thorough knowledge about welding machines or to a qualified operator.
- For safety, leave the operation of the machine to a person with complete knowledge of the instruction manual and sufficient skill.
- Do not use this machine for any purpose other than arc welding described in the instruction manual.
- Do not remodel the machine.
- Check the safety around the machine before operation to prevent accidents.
- Be sure to hold the handle when carrying the machine.
- Wear leather gauntlets when touching the machine during welding or right after operation.
Do not touch the welded surface until it has cooled.



WARNING

Strictly observe the following to prevent electric shock.



- Do not touch the charged section; otherwise fatal electric shock or burns can result. When the power on the input side is turned on, the Input circuit and the inside of the welding machine are charged. Even if the input power is turned off, the capacitor may have been charged. When the welding power is output, the electrode and base metal, as well as the metal portion in contact with these, are charged.
- Never touch charged sections.
- The welding power supply case and base metal, as well as jigs electrically connected to them, shall be grounded in conformity with the law (Technical Standard for Electric Equipment) by a qualified electric engineer.
- Turn off all power supplies on the input side by means of switches in the switch boxes before installation, maintenance, and inspection. The capacitor will not discharge completely right after the input power is turned off. Check that no voltage is remaining before maintenance or inspection.
- Periodically conduct maintenance and inspection. Repair damaged parts before resuming operation.
- Do not use cables with insufficient capacity or damaged cables whose conductors are exposed.
- firmly tighten and insulate cable connections.
- Firmly connect the welding cable on the base metal side at a location as close as possible to the base metal.
- Do not use the machine with the welding machine case or cover removed.
- Be sure to cover the input and output terminals before use.
- Do not use broken or wet gauntlets.
- Never fail to use a life-line when working in high places.
- Turn off power switches of all devices and input-side power supply when the machine is not used.
- Do not wear wet clothes.
- Do not stand on or touch the wet floor.
- Do not use the machine outdoors when it is raining.
- Do not leave the machine outdoors after use.
- Be sure to install a fuse or breaker on the input power supply side.
- Check the supply voltage of the machine before use.
The tolerance for the input supply voltage is plus or minus 10% of the rating. Use of the machine out of the tolerance is prohibited.
- The metal receptacle (plug) on the tough-rubber sheath cable is threaded.
Tighten it firmly.
- Be sure to ground the tough-rubber sheath cable of the machine.
- Turn off the power and stop operation in the following cases, and ask an engineer with special knowledge of electricity to repair.
 - *Broken or worn-out cables
 - *Damage due to water leakage or other liquid
 - *Malfunction of the machine in spite of operation in conformity with the instruction manual.
 - *Breakdown of the machine.
 - *Abnormal performance of the machine which requires tune-up.
- Ask an engineer with expertise to maintain, inspect, or repair the machine.
- Please make sure that any foreign material does not attach to the connector of the machine nor to the plug of the power cable when the plug of the power cable is connected to the machine. Foreign materials can cause short-circuits or melt the connector.

**CAUTION**

Use protective gear to protect you and others from arc light, scattered spatters/slugs, and noise.



- The arc light includes harmful ultraviolet rays and infrared rays, causing inflammation of eyes or burns.
- Scattered spatters and slugs can damage your eyes and cause burns.
- Noise can cause hearing difficulties.
- Wear light-shielding goggles or hand shield, which blocks light sufficiently, for welding operation or monitoring welding.
- Wear protective goggles to protect your eyes from spatters and slugs.
- Install a protective curtain around the welding site so that arc light will not reach the eyes of people around the site.
- Wear protective gear such as leather gauntlets, clothes with long-sleeves, leg cover, leather apron, helmet, and safety shoes.
- When the noise level is high, wear a noise-proofing protector.

**CAUTION**

Use protective gear to protect you and others from fumes and gas generated by welding.



- Welding generates fumes and gas. Inhalation of such fumes and gas can damage your health.
- Welding operation in a small space causes deficiency of oxygen, which is very likely to cause suffocation.
- To prevent gas poisoning and suffocation, use the local waste disposal facilities stipulated by the law (Industrial Safety and Health Law and Regulations to Prevent Damage due to Dust) or use an effective inhaler.
- When the welding space is small, ventilate the space sufficiently or wear an inhaler. Have a trained watchman monitor welding.
- Welding operation near places where degreasing, washing, or oiling is conducted may lead to generation of harmful gas. Do not conduct welding near such places.
- Welding zinc plated steel sheets or other coated steel sheets will generate harmful fumes. Remove the coating before welding, or wear an inhaler before operation.

**CAUTION**

Strictly observe the following to prevent gas cylinders from falling or bursting.



- Gas cylinders, when they fall, can cause accidents leading to death or injury.
- High-pressure gas is contained in gas cylinders. Improper handling of gas cylinders can cause a burst or emission of high-pressure gas, causing accidents that lead to death or injury.
- Handle gas cylinders in conformity with the law (High Pressure Gas Control Law).
- Do not expose gas cylinders to high temperatures.
- Set gas cylinders in a special cylinder stands to prevent the gas cylinders from falling.
- Never generate arcs on gas cylinders. Do not hook the welding torch on gas cylinders, or do not allow electrode to touch gas cylinders.
- Do not bring your head close to the discharge port when opening the valve on the gas cylinder.
- Attach a protective cap to gas cylinders when they are kept unused.
- Use a gas flow rate controller made or recommended by a welding machine manufacture.
- Read the instruction manual for the gas flow rate controller before use, and strictly observe the precautions.
- Never use a gas cylinder from which gas is leaking or a broken gas cylinder.
- Use gas cylinders only for specified purposes.
- DO not apply oil or grease to the valve on gas cylinders.
- When the valve on gas cylinders is hard to open, contact the dealer.

**CAUTION**

Strictly observe the following to prevent injury due to rotary section.



- Do not bring your hands, hair, or clothes close to the cooling fan of the welding power supply or the feeder roller of the wire feeder; otherwise you can be caught in them.
- Do not bring your head near the end of the welding torch during wire inching; otherwise the wire may stick in your eyes.
- When the spool of wire is released, you can get hurt.
- Do not use the welding machine with its case or cover removed.
- Ask a trained person who has thorough knowledge of welding machines or a qualified person to remove the case for maintenance, inspection, or repair. Install a protective fence around the welding machine to prevent people from getting near carelessly.
- DO not bring your hand, fingers, hair, or clothes close to the rotating cooling fan or the roller of the feeder.
- Do not bring your head near the end of the welding torch during wire inching.
- Secure the end of the wire with the wire stopper on the spool when storing or moving the spool of wire or when setting it in the wire feeder.
- When inserting the spool of wire into the wire guide on the wire feeder, firmly hold the wire so that it will not be released.

**CAUTION**

Strictly observe the following to prevent fire, explosion, or burst.



- Spatters and hot base metal right after welding can cause fire.
- Imperfect connection of cables or imperfect contact on the route of the electric current on the steel bar and other base metal can cause fire because of heating due to resistance.



- Arcs generated on the container of gasoline or other inflammables can cause explosion.
- Welding of sealed tanks or pipes can cause bursts.
- Do not do welding in a place where scattered spatters will be in contact with inflammables.
- Do not do welding in a place near inflammable gas.
- Do not bring hot base metal right after welding close to inflammables.
- Welding on ceilings, floors, or walls may cause fire on the hidden side. Remove inflammables from the hidden side.
- Firmly tighten cable connections, and firmly connect the welding cable on the base metal side at a location as close as possible to the base metal.
- Do not weld gas pipes filled with gas.
- Do not weld sealed tanks or pipes.
- Provide a fire extinguisher near the welding place to prepare for the worst.
- Do not weld a container that has inflammables inside.
- Do not have a lighter, matches, or other inflammables with you during welding.

2 Location of Safety labels

Safety labels and labels for correct operations are stuck to the machine.

- Carefully read labels before operation and follow the instructions decried on them.
- Never peel off the labels. Keep them clean and legible at all times.

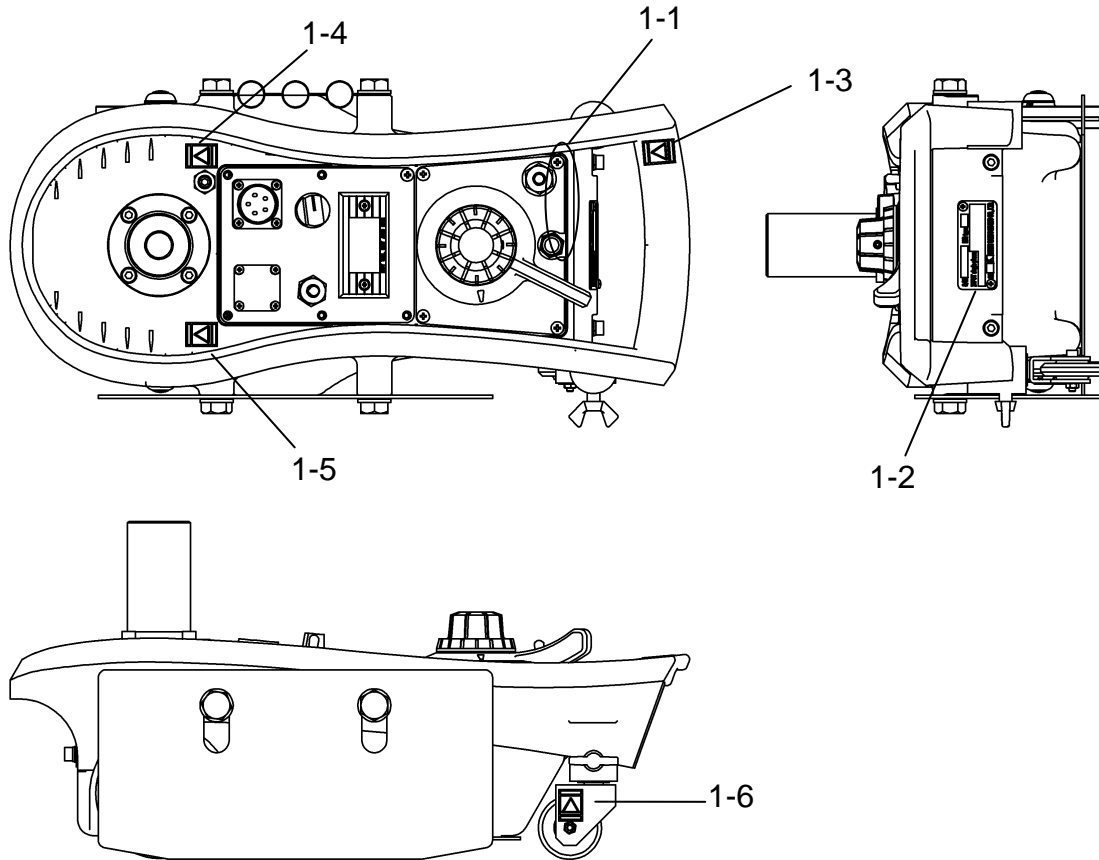

NET weight 8.5kg Made in Japan

1-1

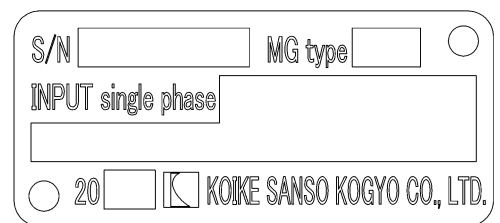

1-2



1-3



1-4



1-5



1-6

3 Overview of the Unit

3.1 Features of the Unit

- 1) It offers excellent operability.
- 2) It can travel over a wide speed range, from 40~2400 mm/min/1.575~94.488 inch/min.
- 3) It incorporates a motor equipped with an encoder and the actual speed is displayed on a digital meter.
- 4) three speed settings can be saved by using the speed presetting function.
- 5) Pressing a button instantly switches to slow travel to help to prevent uncut material being left at the start and finish ends when cutting thick material.
- 6) The incorporated arc coupling function enables both plasma cutting and arc welding by changing the torch set.
- 7) A weaving control function is incorporated, making it possible to perform weaving welding by installing the kit to mount the WU-3R weaving unit, with no need to add a control box.
- 8) Torch sets, rails and other accessories of the existing IK-12max3 model can be used without modification.

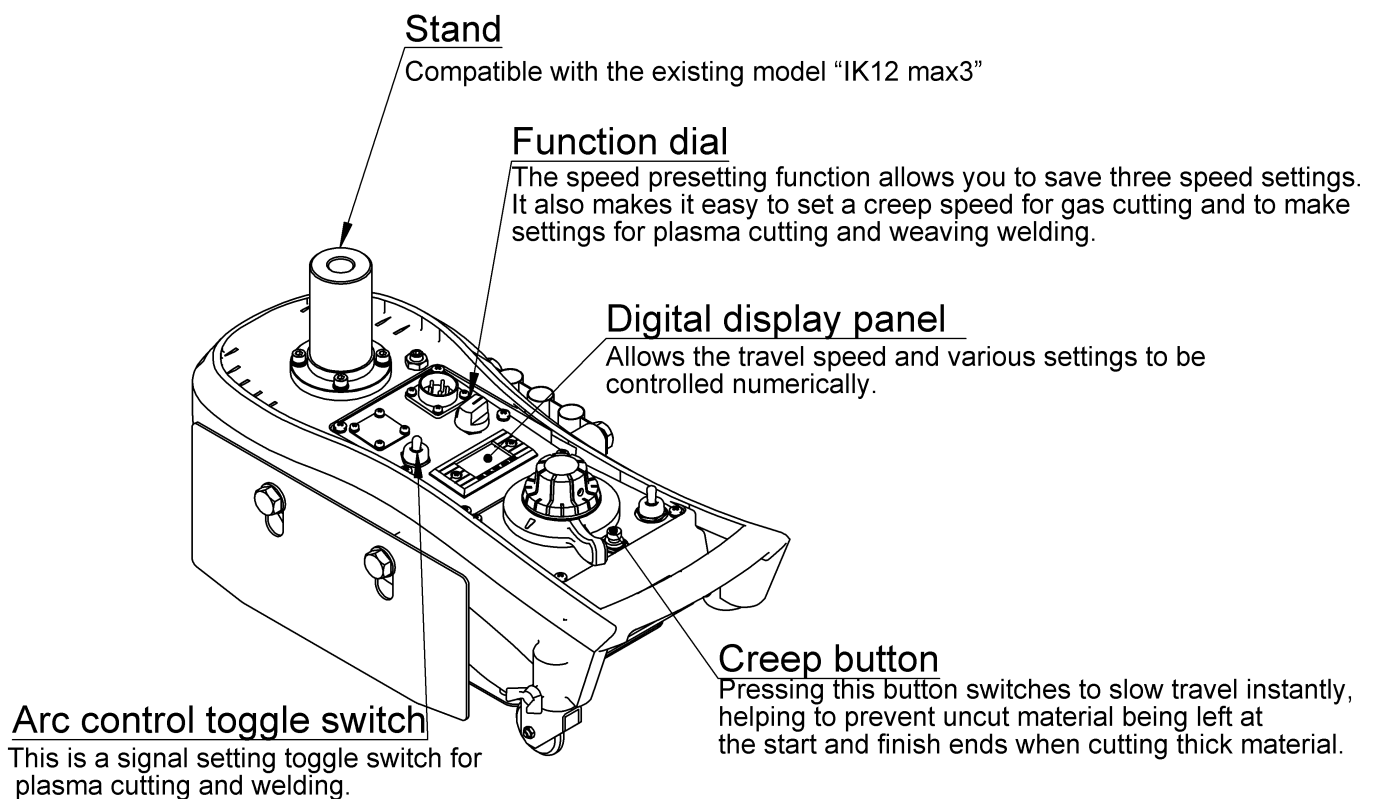

3.2 Specifications

Weight (body):	8.5Kg/18.74lb
Machine size:	432mm/17inch
Machine width	220mm/8.66inch
Wheel width	160mm/6.3inch
Power source:	AC100~240V±10% 1.1~0.7A 50-60Hz
Motor:	DC24V motor with an encoder 23W 5600rpm
Transmission	Dial acceleration formula、 Variable speed
Traveling speed	40~2400mm/min/1.57~94.49inch
Creep speed	40~300 mm/min/1.57~11.81inch
Speedometer	digital display
Max loaded weight	50kg/110.23lb



●option

- 1) Rail (1.8M)
- 2) Circle rail
- 3) Circle cutting attachment
- 4) S-100 torch set
- 5) S-200 torch set
- 6) SP-100 torch set
- 7) SP-200 torch set
- 8) SR-100 torch set
- 9) SR-200 torch set
- 10) SPR-100 torch set
- 11) SPR-200 torch set
- 12) SP-300 torch set
- 13) SP-400 torch set
- 14) L-100 torch set
- 15) 6023 thick cutting set
- 16) EPOCH300 thick cutting set
- 17) EPOCH600 thick cutting set
- 18) A type holder set for welding
- 19) TYPE-F WELDING HOLDER SET
- 20) TYPE-F WU-3R WEAVING HOLDER SET
- 21) TYPE-F PLASMA HOLDER SET
- 22) Cooling fan



3.3 Contents of package

- Body 1set
- Chip support 1set
- Hexagon bolt M10×20(WF) 2pieces
- Power cable (5P×5M) One
- Instruction manual、 Written guarantee 1pc each

4 Method of operation

 WARNING	<p>Kindly take care about following things to avoid getting an electric shock.</p>
	<ul style="list-style-type: none"> ● Kindly remove input plug from outlet while checking, dis-assembling or repairing and turn OFF the control source while leaving. If it is necessary to carry out checking in the energized state, professional engineer having enough knowledge and skill about electric handling should go since there is risk of short circuit, getting electric shock.
<ul style="list-style-type: none"> ● Do not use welding equipment without case or cover. ● Kindly use power outlet with earth pin outlet since input plug has earth pin. It is connected to main body of carriage in operation panel. ● Kindly use input voltage within $\pm 10\%$ for power supply input to input plug (Kindly use input voltage in the range of AC100V~AC240V) There is risk of short circuit due to failure of printed board on operation panel. ● In case of crack in insulation cover of power cable and torch cable, do not expose it to high temperature. There is risk of short circuit due to tearing of insulation covering. ● Kindly weld below the rated current and usage rate of torch to prevent dielectric breakdown due to overheating. ● Kindly place power cable and torch cable in proper manner so that they are not stretched or pulled. There is possibility of breakage of insulation by damaging holding part and connector part due to pulling. ● Do not throw or drop main body of carriage. There is risk of damaging insulation by breaking. ● While connecting to power cable plug to main body, kindly connect after verifying that foreign object is not touching to connector of main body, power cable plug. There is risk of connector erosion due to short circuit by foreign object. 	

 WARNING	<p>Strictly observe the following to prevent burns.</p>
<ul style="list-style-type: none"> ■ Never directly touch the torch nozzle, tip, orifice, insulation cylinder, and the surface of the carriage which are very hot right after welding. 	

 WARNING	<p>Kindly take care about following things to avoid falling off of carriage</p>
	<ul style="list-style-type: none"> ● Do not lift the carriage by holding its Handle. There is risk of falling off carriage while holding carriage by handle, if there is shock impact at carriage or if mounting screw of handle is loose.



CAUTION

Set the welding power switch in the "No Self-Holding (or No Crater Treatment)" position.

- When the switch of the welding power supply, which is to be connected to the welding machine, is set in the "Self.Holding (or Crater Treatment)" position, the welding arc will not stop even if the welding operation is stopped.

4.1 Name of each parts

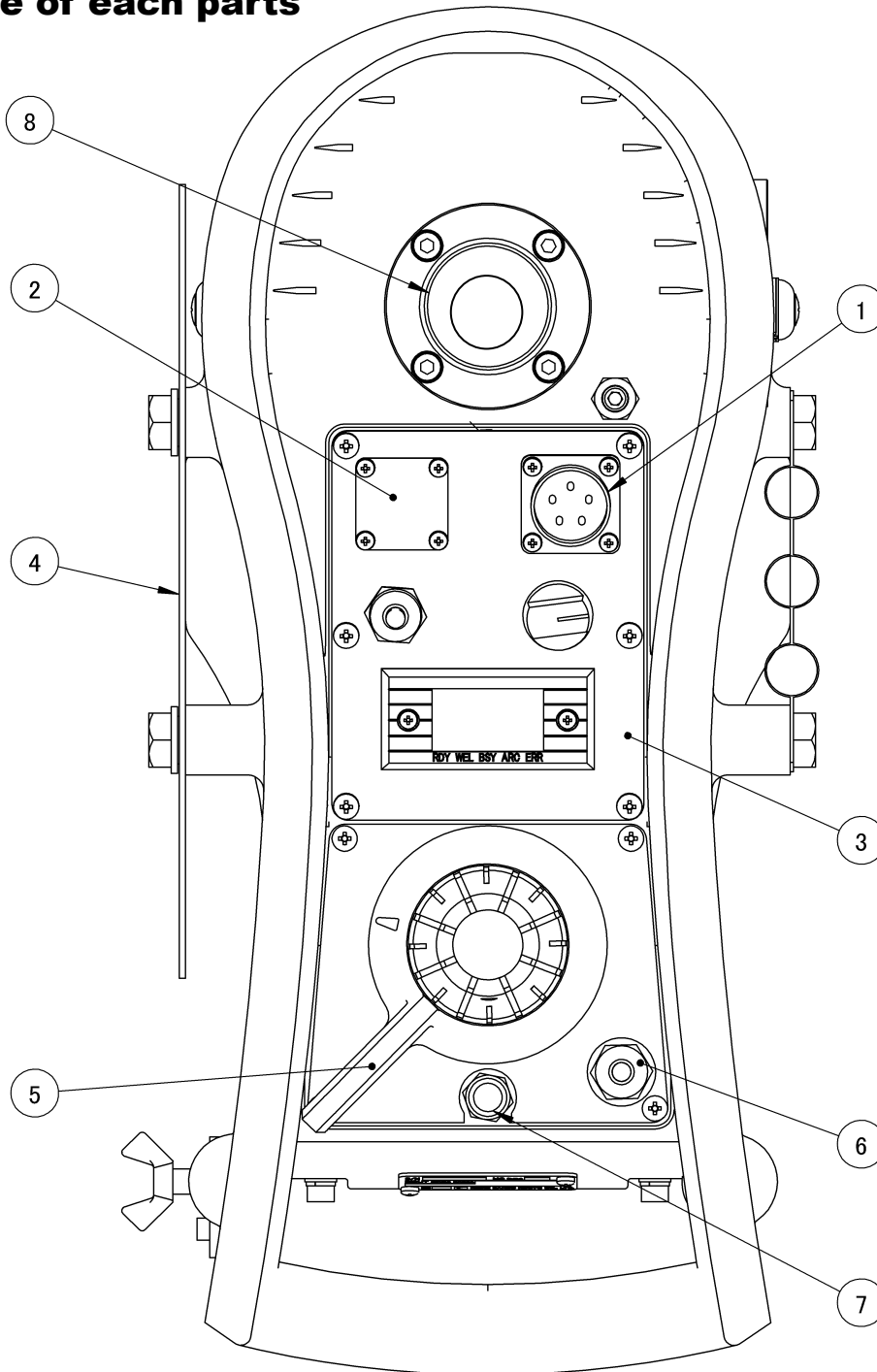

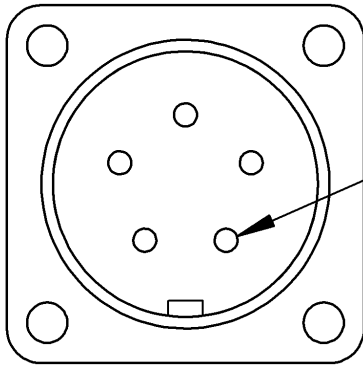

Fig.1 Name of each part

(1) Receptacle

Kindly connect power cable to this receptacle.

	WARNING
Never fail to ground the clip.	
	■ The grounded clip prevents short circuits or electric shock which results from a short circuit in the carriage, etc.



Ground wire position (No.3)

(2) Operation plate cover

If you want to connect the weaving unit WU-3R (sold separately) option, remove the plate, Masu mounting a receptacle for WU-3R. Refer the volume that how to use method of WU-3R (Weaving unit WU-3R instruction manual).

	In case if you connected WU-3R make sure Turn Off the Power
CAUTION	
■ When the power is on if it gets connected there is a possibility of failure	

(3) Operation panel

The detail is shown below.

(4) Heat insulating plate

It prevents heat from gas · plasma cutting · welding.

(5) Clutch lever

Switch the clutch on / off by operating the steering wheel.

When the position of the arrow is START, the clutch is ON, and when it is STOP it is OFF.

(6) Direction selector switch

It is used when starting the running of carriage or stopping the running of the carriage.

(7) CREEP button

Switch to creep speed, single action of weaving or when determining parameters.

(8) Stand



Use it for mounting each torch set. There is a long length as an option.

Standard : 84L

Option : 114L、180L、300L、400L、500L





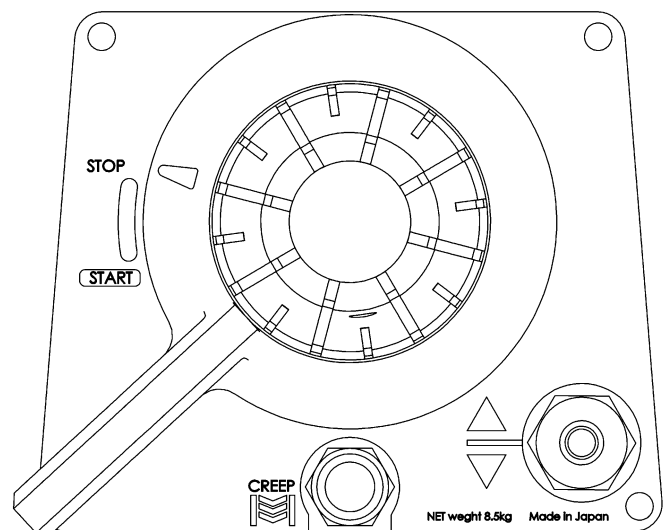
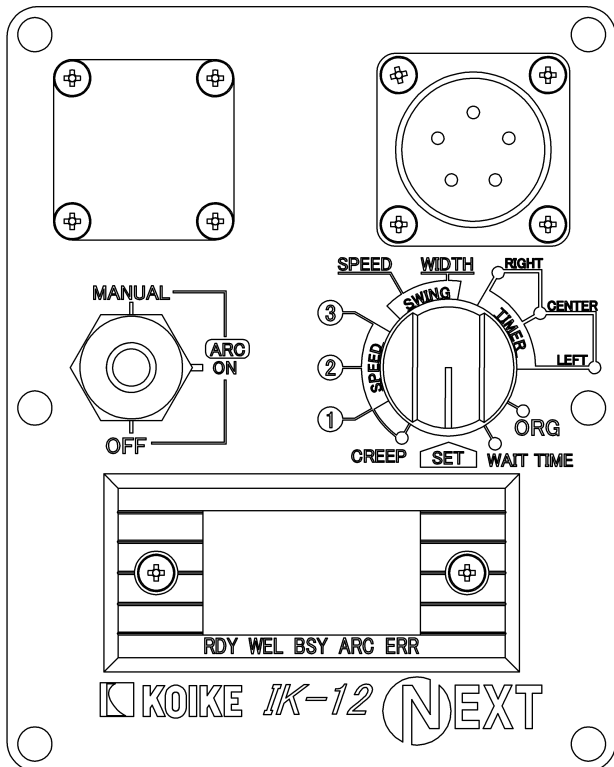

4.2 Operation panel

V4.02

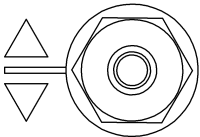
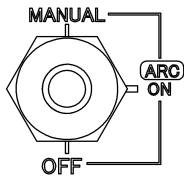
 <p>WARNING</p>	<p>Kindly take care about following things to avoid getting an electric shock.</p>
	<p>■ Kindly remove input plug from outlet while checking, dis-assembling or repairing and turn OFF the control source while leaving. If it is necessary to carry out checking in the energized state, professional engineer having enough knowledge and skill about electric handling should go since there is risk of short circuit, getting electric shock.</p>
<ul style="list-style-type: none"> ● Do not use welding equipment without case or cover. ● Kindly use power outlet with earth pin outlet since input plug has earth pin. It is connected to main body of carriage in operation panel. ● Kindly use input voltage within $\pm 10\%$ for power supply input to input plug (Kindly use input voltage in the range of AC100V~AC240V) There is risk of short circuit due to failure of printed board on operation panel. ● In case of crack in insulation cover of power cable and torch cable, do not expose it to high temperature. There is risk of short circuit due to tearing of insulation covering. ● Kindly place power cable and torch cable in proper manner so that they are not stretched or pulled. There is possibility of breakage of insulation by damaging holding part and connector part due to pulling. ● Never fail to turn OFF the power switch (1) before attaching or detaching the metal plug. ● When you remove the plug, put rubber cap on the receptacle to prevent dust and dirt. ● When you found dust and dirt in the receptacle, remove these before connecting electric power cable plug. 	

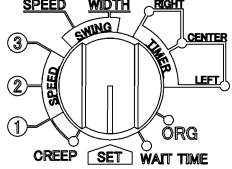
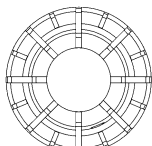

4.2.1 Explanation of the Operation Panel

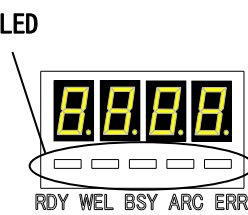



Indication	Name	Function		
	Direction selection switch	<p>This switch is used to start, or stop, travel of the carriage. On flipping the switch while the multi-function selector switch is set to any of the SPEED (1) to (3) positions, the carriage will travel in the direction of the arrow flipped to. Setting the switch at the neutral position stops the carriage.</p>		
	Arc selection switch	<p>This three-point selection switch allows selection of the following three modes. MANUAL: Use this position for wire inching and arc tests. * An arc is generated while the tip of the torch is in contact with the material to be welded. Be careful. ARC ON: Use this position for normal operation. When the carriage starts traveling, the arc signal is output. OFF: While at this position, the arc signal is not output and only carriage travel is possible.</p> <table border="1" data-bbox="657 728 1484 851"> <tr> <td data-bbox="657 728 869 851">  Note </td> <td data-bbox="869 728 1484 851"> Do not operate the direction selection switch while this switch is flipped to the MANUAL side. </td> </tr> </table> <ul data-bbox="657 851 1484 1160" style="list-style-type: none"> • If the direction selection switch is operated while this switch is flipped to the MANUAL side, the arc signal will continue to be output after it is returned to ARC ON, and the carriage will travel if it is set to OFF. Setting the direction selection switch to neutral stops output of the arc signal and travel of the carriage. If the direction selection switch has been operated while this switch is flipped to the MANUAL side, turn the power OFF and back ON. 	 Note	Do not operate the direction selection switch while this switch is flipped to the MANUAL side.
 Note	Do not operate the direction selection switch while this switch is flipped to the MANUAL side.			
	Multi-function selector switch	<p>This switch is used to select each parameter and to select the travel mode. For details on each parameter, check 4.2.2 About the multi-function selector switch.</p>		
	Volume switch	<p>This switch is used to set the carriage travel speed and each parameter. Turning it clockwise increases the value and turning it counterclockwise reduces the value. Turning the switch quickly magnifies the increase/decrease.</p>		
	CREEP button	<p>This button is used to start creeping. It may also be used when confirming parameters. * When an error has occurred, pressing the START/STOP switch resets the error display. However, if the cause of the error occurrence remains, the error will occur again. Check what action to take against each error and eliminate the cause.</p>		
	Digital meter	<p>The digital meter displays the speed of the carriage or the value of each parameter. The LED display on the digital meter indicates the operation status of the carriage. RDY: Lit while the carriage power is on. WEL: Lit while the arc signal is being output while the carriage is traveling. BSY: Lit while the carriage is traveling, irrespective of whether there is an arc signal or not. ARC: Lit while the arc selection switch is at the MANUAL or ARC ON position. ERR: Lit when an operation error has occurred. At this time, the digital meter displays the error number corresponding to the error details.</p>		



Error number	Error details	Cause	Corrective action
<About error numbers> Error indications are three-digit numbers that start with "E.". Example indication E010			
001	Link unit configuration failure error	There may be a contact failure in the wiring between electrical boards (connector numbers CN2, 3 for all boards in common, connector numbers CN4, 5 for the L-DSP display board).	Check for cable disconnections, and for contact failures of connectors and crimp-type terminals. (The LEDs on each board will flash when the power is turned on: if the LEDs do not flash or light, the circuit board may be faulty.)
002	Power failure detection error	This is an error that occurs on other equipment.	In the event that it is displayed, contact the distributor where you purchased this product or our sales office.
003	Inverter error		
004	Emergency stop error		
005	3-phase power supply error		
006	Breaker OFF error		
007	Encoder line connection error	The encoder line may be connected to MD-CN10 on the L-MD-A board.	Connect the encoder line to MD-CN5.
008	Motor deviation error	There may be a contact failure on the motor line or the encoder line.	Check for disconnections in all wires, and for contact failures of connectors and crimp-type terminals. Connect the motor line to MD-CN4, and the encoder line to MD-CN5, on the L-MD-A board.
010	Welding current detection signal ON timeout (5 seconds) error	This is an error that occurs on other equipment.	In the event that it is displayed, contact the distributor where you purchased this product or our sales office.
011	Signal logic inversion error while detecting welding current		
012	Encoder selection error		
013	Unit configuration unsuitable error		
014	Weld movement distance during tack operation error		
016	Servo driver error	This is an error that occurs on other equipment.	In the event that it is displayed, contact the distributor where you purchased this product or our sales office.
017	Copying signal error		
018	Thermal guard error		
019	Thermal guard error		
020	Link unit configuration failure error		
021	X-axis-direction derailing error		
022	Y-axis-direction derailing error		
023	Z-axis-direction derailing error		
024	Motor overload error (encoder equipped)	An abnormal load may be being applied to the drive section or motor.	Remove any abnormal load from the drive section or motor.
025	Carriage backup error (Parameter)	It is possible that the power was turned off during carriage operation or fine adjustment movement by limit switch, and the backup was not implemented correctly.	Turn the power off and back on again. If the error display indication is not cleared after repeating the above several times, replace all the circuit boards being used.
026	Carriage backup error (System Parameters)		
125	WU-3R backup error (parameter)	This is an error that occurs on other equipment.	In the event that it is displayed, contact the distributor where you purchased this product or our sales office.
126	WU-3R backup error (System Parameters)		
<p>※ To recover from an error, unplug the power cable from the operation panel, turn off the power supply, check the corrective action described above, plug the power cable back into the operation panel and turn the power back on.</p> <p>※ When an error occurs, the error indication is reset by pressing the CREEP button, but eliminate the cause by referring to the corrective action described above before pressing the button.</p>			

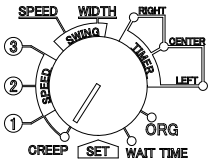

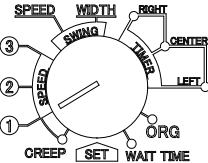
4.2.2 About the multi-function selector switch



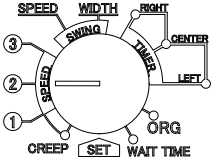

With IK-12 NEXT, various operations can be set by selecting individual modes and parameters with the multi-function selector switch.

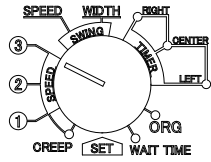

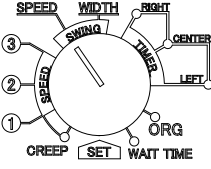

The individual modes and parameters are as follows.

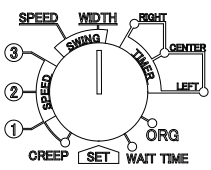

Operation Panel Indication	Digital Display	Setting Range	Default Value
		40~300 mm/min	100mm/min
		1.574~11.811 inch/min	3.937 inch/min
		Function	
		<p><u>CREEP travel speed setting</u></p> <p>Select this mode to change <u>the speed during CREEP travel</u></p> <p>The carriage travels at the speed set in the CREEP travel mode only when the CREEP button is pressed while the carriage is traveling or when this mode has been selected with the multi-function selector switch</p> <p>The value for the CREEP travel speed is displayed while the carriage is stopped and while it is traveling.</p> <p>The travel speed of the carriage can be changed by turning the volume switch while the carriage is stopped and while it is traveling. To increase the speed, turn it clockwise, and to decrease the speed turn it counterclockwise.</p>	
		40~2400 mm/min	40mm/min
		1.574~94.488 inch/min	1.575 inch/min
		Function	
		<p><u>Travel mode (1)</u></p> <p>Select this mode to make the carriage <u>travel</u>.</p> <p>When the direction selection switch is flipped while this mode is selected, the carriage will start traveling in the direction of the arrow. Selecting this mode while the carriage is traveling causes the travel speed of the carriage to change to the set speed.</p> <p>The value for the carriage travel speed is displayed while the carriage is stopped and while it is traveling.</p> <p>The travel speed of the carriage can be changed by turning the volume switch while the carriage is stopped and while it is traveling. To increase the speed, turn it clockwise, and to decrease the speed turn it counterclockwise.</p>	

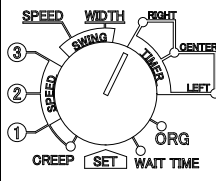

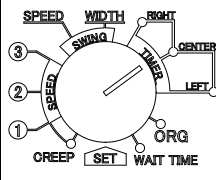

Operation Panel Indication	Digital Display	Setting Range	Default Value
		40~2400 mm/min	500mm/min
		1.574~94.488 inch/min	19.685 inch/min
		Function	
		<p>Travel mode (2) Select this mode to make the carriage Travel. When the direction selection switch is flipped while this mode is selected, the carriage will start traveling in the direction of the arrow. Selecting this mode while the carriage is traveling causes the travel speed of the carriage to change to the set speed. The value for the carriage travel speed is displayed while the carriage is stopped and while it is traveling. The travel speed of the carriage can be changed by turning the volume switch while the carriage is stopped and while it is traveling. To increase the speed, turn it clockwise, and to decrease the speed turn it counterclockwise.</p>	

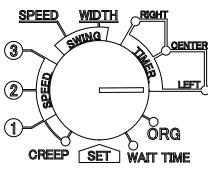
Operation Panel Indication	Digital Display	Setting Range	Default Value
		40~2400 mm/min	2400mm/min
		1.574~94.488 inch/min	94.488 inch/min
		Function	
		<p>Travel mode (3) Select this mode to make the carriage Travel. When the direction selection switch is flipped while this mode is selected, the carriage will start traveling in the direction of the arrow. Selecting this mode while the carriage is traveling causes the travel speed of the carriage to change to the set speed. The value for the carriage travel speed is displayed while the carriage is stopped and while it is traveling. The travel speed of the carriage can be changed by turning the volume switch while the carriage is stopped and while it is traveling. To increase the speed, turn it clockwise, and to decrease the speed turn it counterclockwise.</p>	

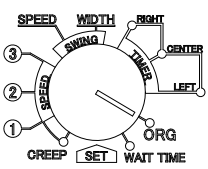
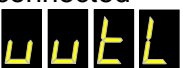

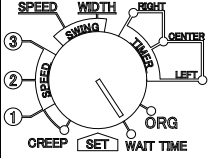

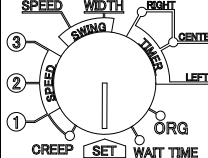

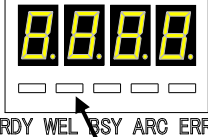

Operation Panel Indication	Digital Display	Setting Range	Default Value
	When WU-3R not connected	400~1500 mm/min 15.748~59.055 inch/min	400mm/min 15.748 inch/min
		Function	
	<p>Weaving Oscillation Speed Setting</p> <p>Select this mode to set the oscillation speed during weaving operation. The digital meter displays the oscillation speed value while the carriage is stopped and while it is traveling.</p> <p>The digital meter displays the oscillation speed value while the carriage is stopped and while it is traveling.</p> <p>The oscillation speed can be changed by turning the volume switch while the carriage is stopped and while it is traveling.</p> <p>The oscillation speed can be changed by setting the multi-function selector switch to SWING SPEED while the carriage is stopped and while it is traveling.</p> <p>Pressing the CREEP button while the carriage is stopped and the multi-function selector switch is set to SWING SPEED starts weaving as an independent operation. (No arc is generated in independent operation.)</p> <p>This is not used when no weaving unit is connected.</p>		
	When WU-3R connected		
Operation Panel Indication	Digital Display	Setting Range	Default Value
	When WU-3R not connected	0~100.0 mm 0~3.937 inch/min	10.0mm 0.394 inch
		Function	
	<p>Weaving Oscillation Width Setting</p> <p>Select this mode to set the oscillation width during weaving operation. The digital meter displays the oscillation width value while the carriage is stopped and while it is traveling.</p> <p>The oscillation width can be changed by turning the volume switch while the carriage is stopped and while it is traveling.</p> <p>The oscillation width can be changed by setting the multi-function selector switch to SWING WIDTH while the carriage is stopped and while it is traveling.</p> <p>Pressing the CREEP button while the carriage is stopped and the multi-function selector switch is set to SWING WIDTH starts weaving as an independent operation. (No arc is generated in independent operation.)</p> <p>This is not used when no weaving unit is connected.</p>		
	When WU-3R connected		

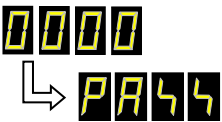
Operation Panel Indication	Digital Display	Setting Range	Default Value
	When WU-3R not connected 	0~10.0 s	0s
	Function		<p>Right Torch Stop Time Setting</p> <p>Select this mode to set the right torch stop time during weaving operation.</p> <p>The digital meter displays the right torch stop time value while the carriage is stopped and while it is traveling.</p> <p>The right torch stop time can be changed by turning the volume switch while the carriage is stopped and while it is traveling.</p> <p>The right torch stop time can be changed by setting the multi-function selector switch to TIMER RIGHT while the carriage is stopped and while it is traveling.</p> <p>Pressing the CREEP button while the carriage is stopped and the multi-function selector switch is set to TIMER RIGHT starts weaving as an independent operation. (No arc is generated in independent operation.)</p> <p>This is not used when no weaving unit is connected.</p>
	When WU-3R not connected 	0~10.0 s	0s
	Function		<p>Center Torch Stop Time Setting</p> <p>Select this mode to set the central torch stop time during weaving operation.</p> <p>The digital meter displays the center torch stop time value while the carriage is stopped and while it is traveling.</p> <p>The center torch stop time can be changed by turning the volume switch while the carriage is stopped and while it is traveling.</p> <p>The center torch stop time can be changed by setting the multi-function selector switch to TIMER CENTER while the carriage is stopped and while it is traveling.</p> <p>Pressing the CREEP button with the multi-function selector switch set to TIMER CENTER starts weaving as an independent operation. (No arc is generated in independent operation.)</p>

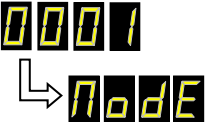
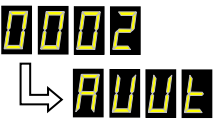
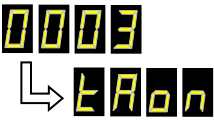
Operation Panel Indication	Digital Display	Setting Range	Default Value
	When WU-3R not connected 	0~10.0 s	0s
	Function		
	<p>Left Torch Stop Time Setting Select this mode to set the left torch stop time during weaving operation. * The left torch stop time in the tack travel mode is also set here. The digital meter displays the left torch stop time value while the carriage is stopped and while it is traveling. The left torch stop time can be changed by turning the volume switch while the carriage is stopped and while it is traveling. The left torch stop time can be changed by setting the multi-function selector switch to TIMER LEFT while the carriage is traveling. Pressing the CREEP button while the carriage is stopped and the multi-function selector switch is set to TIMER LEFT starts weaving as an independent operation. (No arc is generated in independent operation.) This is not used when no weaving unit is connected.</p>		
	When WU-3R connected 	—	—
	Function		
	<p>Origin Position Adjustment Setting The origin position of the torch can be changed by turning the volume switch while the carriage is stopped and while it is traveling. Turning the volume switch clockwise moves the torch to the left. Turning it counterclockwise moves the torch to the right. Pressing the CREEP button while the carriage is stopped and the multi-function selector switch is set to ORG starts weaving as an independent operation. (No arc is generated in independent operation.) This is not used when no weaving unit is connected.</p>		

Operation Panel Indication	Digital Display	Setting Range	Default Value
		0~10.0 s	0s
		<p style="text-align: center;">Function</p> <p>Arc Stabilization Time Setting Select this mode to set the arc stabilization time during traveling mode. This is the time between flipping the direction selection switch and the carriage starting to travel. During arc stabilization time, the arc signal is output while the carriage is stopped, and the time counts down on the digital meter. The value of the arc stabilization time is displayed on the digital meter while the carriage is stopped. The arc stabilization time can be changed by turning the volume switch only while the carriage is stopped. * The arc stabilization time does not work when the arc selection switch is set to OFF. * Do not change to a mode other than the traveling mode with the multi-function selector switch while the direction selection switch is flipped and the countdown for the arc stabilization time is in progress. This may cause the carriage to operate unexpectedly.</p> <div style="border: 1px solid black; padding: 5px;">  <p>Note In order to weld for the arc stabilization time with the initial arc current, an initial arc setting has to be made at the welding power source. The arc stabilization time at the carriage side is essentially the time between flipping the direction selection switch (arc signal ON) and the carriage starting to travel. Check the instruction manual for the welding power source for details on initial arc setting.</p> </div>	
		0000~0011	—
		<p style="text-align: center;">Function</p> <p>Parameter Setting Mode The parameters can be set in this mode. * Operation is only possible while the carriage is stopped. Check Parameter Number Details for details on the parameter numbers. <u>Setting Procedure</u> 1) Turn the multi-function selector switch to  2) Select the parameter number to change by turning the volume switch. 3) Press the CREEP button to confirm. 4) Turn the volume switch to edit. Note that the WEL LED is lit during editing.  Lights 5) After editing is completed, press the CREEP button to confirm.</p>	

Parameter Number Details

Parameter number	Explanation														
	<p>Unintended input prevention setting Parameter editing is enabled when the value of this parameter is  If it is any other value, input is possible only for this parameter. Use this to prevent unintended input. Setting range: 0000~9999 At shipment from factory : 0114</p>														
	<p>Not used</p>														
	<p>Arc Stabilization Time Setting Setting range: 0~10.0 s At shipment from factory: 0 s * This setting can also be made at the WAIT TIME position of the multi-function selector switch.</p>														
	<p>Torch Switch ON Output Time Setting (Crater Filling) Setting range: -0.1~1.0 s At shipment from factory: 0 Sets the output ON time for the arc signal.</p> <ul style="list-style-type: none"> • If the power supply setting is not self-latching (crater filling not supported), set this parameter to 0. • Set this value to between 0.4 and 1.0 if the power supply setting is self-latching (crater filling supported) • If the value above is set and the arc is frequently interrupted, set the value to -0.1. In this case, the signal will remain in the ON state up until the arc stop timing. However, since the specifications of some welding power sources do not support the setting of -0.1, set the value to 1.0 and adjust. <table border="1" data-bbox="475 1151 1230 1285"> <tr> <td>crater (self-latching)"ON"</td> <td>crater (self-latching)"OFF"</td> </tr> <tr> <td>Welding with crater current</td> <td>Welding with main current</td> </tr> </table> <p>※Precautions on Use Be sure to make the crater filling (self-latching) setting at the welding power source and that at the carriage agree Set the crater filling (self-latching) switch of the welding power source according to the following table. Please set in “parameter setup mode No.0003” the setting method of the truck side.</p> <table border="1" data-bbox="475 1509 1347 1794"> <tr> <td>Welding power source side</td> <td>carriage side</td> </tr> <tr> <td>crater (self-latching) "ON"</td> <td>-0.1 or 0.4~1.0</td> </tr> <tr> <td colspan="2" style="text-align: center;">← match →</td> </tr> <tr> <td>crater (self-latching) "OFF"</td> <td></td> </tr> </table> <table border="1" data-bbox="475 1845 1347 2033"> <tr> <td style="text-align: center;">  CAUTION </td> <td> If the settings do not agree, the welding operation may not proceed as set. Be sure to make the crater filling (self-latching) settings agree. </td> </tr> </table>	crater (self-latching)"ON"	crater (self-latching)"OFF"	Welding with crater current	Welding with main current	Welding power source side	carriage side	crater (self-latching) "ON"	-0.1 or 0.4~1.0	← match →		crater (self-latching) "OFF"		 CAUTION	If the settings do not agree, the welding operation may not proceed as set. Be sure to make the crater filling (self-latching) settings agree.
crater (self-latching)"ON"	crater (self-latching)"OFF"														
Welding with crater current	Welding with main current														
Welding power source side	carriage side														
crater (self-latching) "ON"	-0.1 or 0.4~1.0														
← match →															
crater (self-latching) "OFF"															
 CAUTION	If the settings do not agree, the welding operation may not proceed as set. Be sure to make the crater filling (self-latching) settings agree.														

0004 └─┬─┬─┬─┬─┬─ rUUE	Not used
0005 └─┬─┬─┬─┬─┬─ rPo4	Not used
0006 └─┬─┬─┬─┬─┬─ r4Pd	Not used
0007 └─┬─┬─┬─┬─┬─ cont	Not used
0008 └─┬─┬─┬─┬─┬─ tAn,	<u>Torch switch signal minimum time setting</u> Setting range: 0.4~1.5 s At shipment from factory: 0.7 s Sets the time to guarantee the ON/OFF state of the torch switch. Reducing this value may mean that the welding power source is unable to receive a signal, so care is required.
0009 └─┬─┬─┬─┬─┬─ n-in	<u>Speed, Position Display Unit, Inch Setting</u> 0 : mm display 1 : Inch display After setting this parameter, switch the power off and back on.
0010 └─┬─┬─┬─┬─┬─ conP	<u>Speed Correction</u> Setting range: 50~200% At shipment from factory : 100% Sets the value for correcting the actual speed with respect to the speed indicated at the digital display. Actual speed = speed displayed × [This parameter value]%
0011 └─┬─┬─┬─┬─┬─ DEF	Not used
0012 └─┬─┬─┬─┬─┬─ tYPE	<u>Model Selection Setting</u> 0: WH-MULTI NEXT 1: IK-12NEXT After setting this parameter, switch the power off and back on. When using the IK-12NEXT, be sure to set this parameter to 1.
0013 └─┬─┬─┬─┬─┬─ cP4d	<u>Creeping mode</u> * This is the same as the CREEP setting made with the multi-function selector switch. Use the CREEP setting on the multi-function selector switch.
0014 └─┬─┬─┬─┬─┬─ 4Pd1	<u>Travel mode (1)</u> * This is the same as the SPEED (1) setting made with the multi-function selector switch. Use the SPEED (1) setting on the multi-function selector switch.
0015 └─┬─┬─┬─┬─┬─ 4Pd2	<u>Travel mode (2)</u> * This is the same as the SPEED (2) setting made with the multi-function selector switch. Use the SPEED (2) setting on the multi-function selector switch.

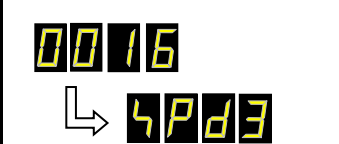
	<p>Travel mode (3) * This is the same as the SPEED (3) setting made with the multi-function selector switch. Use the SPEED (3) setting on the multi-function selector switch.</p>
---	--

4.2.3 Weaving movement time chart

The weaving movement at the time of the weaving welding becomes like the following time chart.

Example1) Parameter settings

- Central torch stop time 0sec
- Left torch stop time 0sec
- Right torch stop time 0sec
- Weaving swing width 10mm / 0.39inch

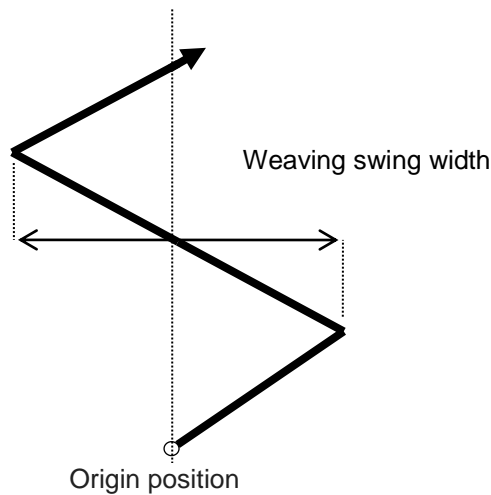

Example2) Parameter settings

- Central torch stop time 1.0sec
- Left torch stop time 1.0sec
- Right torch stop time 1.0sec
- Weaving swing width 10mm / 0.39inch

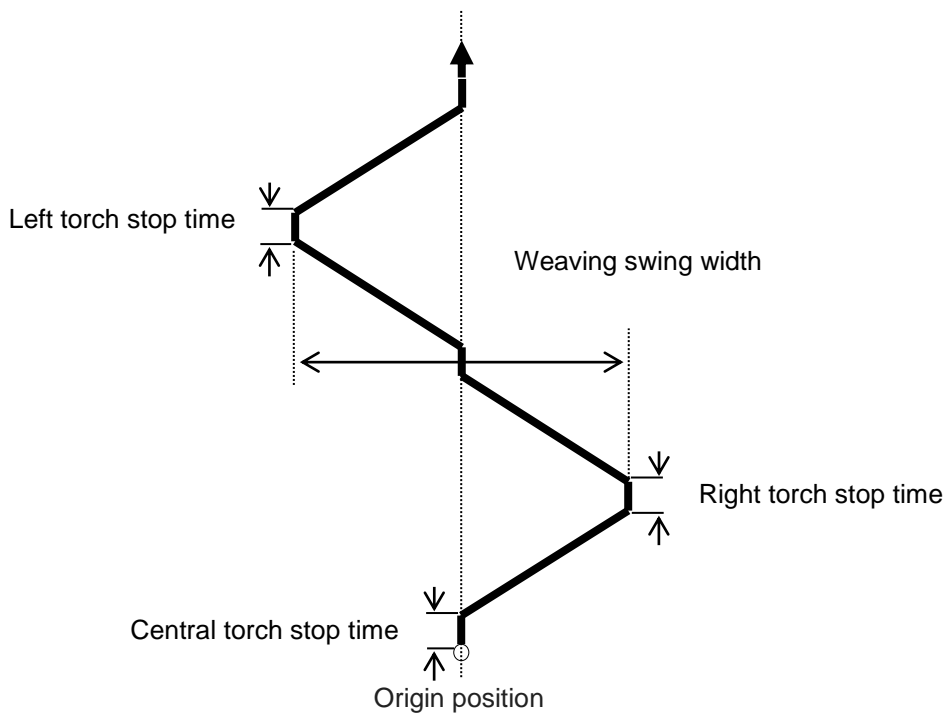

※Weaving swing width, swing speed is the numerical value of at a distance 100mm from the center of rotation.

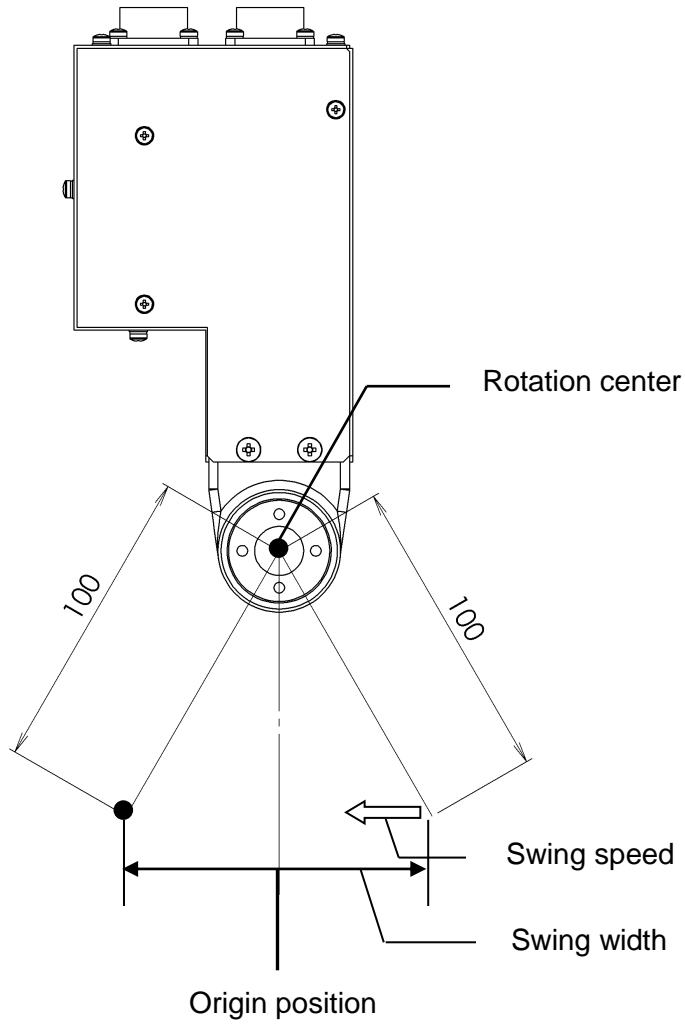

5 Gas cutting operation

5.1 Standard composition of gas equipment

1) Composition of gas equipment for linear and parallel cutting

Composition	F-type single torch set	F-type two torch set	E-type single torch set	E-type two torch set
Pipe arm	Pipe arm 350L	Pipe arm 500L	Pipe arm 350L	Pipe arm 500L
Arm holder	○	○	○	○
Distributor	Single distribution with valve	Double distribution with valves	Single distribution with valve	Double distribution with valves
Torch holder	1set	2set	1set	2set
Torch	1pc(No rack)	2pcs(No rack)	1pc(No rack)	2pcs(No rack)
Hose	600L (OX)2pcs (GAS)1pc	900L (OX)4pcs (GAS)2pcs	600L (OX)2pcs (GAS)1pc	900L (OX)4pcs (GAS)2pcs
Tip	102(acetylene) or 106(propane) #0,1,2each 1pc	102(acetylene) or 106(propane) #0,1,2each 2pcs	102(acetylene) or 106(propane) #0,1,2each 1pc	102(acetylene) or 106(propane) #0,1,2each 2pcs
Guide roller	×	×	○	○
Weight	×	○	×	○

2) Bevel cutting torch set configuration

Composition	SP-300 torch set	SP-400 torch set
Pipe arm	Pipe arm 500L	Pipe arm 500L
Arm holder	○	○
Distributor	Double distribution with valves	Triple distribution with valves
Torch holder	Profiling system	Profiling system
Bevel attachment	For cutting V	For cutting X
Torch	2pcs(With rack)	3pcs(With rack)
Tip	102(acetylene) or 106(propane) #0,1,2each 2pcs	102(acetylene) or 106(propane) #0,1,2each 3pcs
Hose	900L (OX)4pcs (GAS)2pcs	1200L (OX)6pcs (GAS)3pcs
Guide roller	○	○
Weight	○	○

3) Thick cutting torch set configuration

Composition	L-100 torch set	6023 thick cutting set	EPOCH-300 torch set	EPOCH-600 torch set
Pipe arm	Pipe arm 500L	Pipe arm500L	Pipe arm500L	Pipe arm 500L
Arm holder	○	○	○	○
Distributor	Distribution for thick materials	Distribution for 6023	Distribution for EPOCH-300	Distribution for EPOCH-600
Torch holder	φ35 for rack	φ35 for rack	φ35 for rack	φ35 for rack
Torch	A3B2	6023	EPOCH-300	EPOCH-600
Tip	102(acetylene) or 106(propane) #6,7,8 each 2pcs	For 6023 #250, #350	For EPOCH-300	For EPOCH-600
Hose	Flexible hose 3/8 1000L × 3	Flexible hose 3/8 1000L × 3	Flexible hose 3/8 1000L × 3	Flexible hose 1/2 1500L × 1 3/8 1500L × 2
Weight	○	○	○	○
Heat insulating plate	○	For thick cutting	For thick cutting	For thick cutting
Stand	×	×	114L	120L

5.2 Assembling the Unit (for a Single Torch Set)



1. Take the unit body out of the packing box.
2. Fit the primary hose to the gas distributor.
 - Blue hose (oxygen)
 - Red or orange hose (acetylene or LPG)
3. Fit the arm support (set) to the stand and insert the pipe arm into the arm support (set).
4. Insert the torch holder (set) into the pipe arm.
5. Connect the hoses to the distributor and insert them into the stand.
 - ※ When fitting the hoses, check their individual engraved marks and colors: the cutting oxygen (JO) is blue, the preheating oxygen (PO) is blue, and acetylene gas and LPG (AC, LPG) are red or orange.
6. Connect the torch, three single valves (set) and hoses, and insert them into the torch holder.

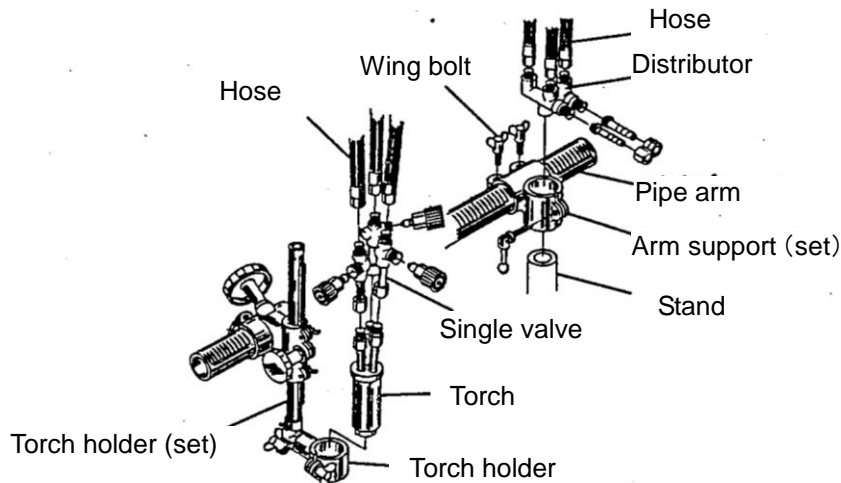

5.3 Preparation for Work



5.3.1 Connecting the cable

1. Connect the cable to the unit body.
 2. Connect the metal plug on the cable to the metal receptacle on the unit side. Make sure that there is no foreign object or debris before plugging it in.
 3. The metal receptacle is fitted with screws. Be sure to tighten the screws in order to prevent the plug coming out while the unit is traveling.
- * When turning on the power supply after turning off the unit body, leave an interval of around three seconds.

5.3.2 Connecting a nozzle

Select the appropriate nozzle from the nozzle capacity standard table according to the thickness of the steel plate to be cut.
Use the top nozzle number in the standard table when the steel plate is very rusty or the groove angle is greater than 20 degrees.
(Nozzle No. "00" or "0" is indicated.)

5.3.3 Connecting the nozzle

1. Select a nozzle according to the thickness of the material to be cut and fit it to the torch. Refer to the nozzle capacity standard table for selection of the nozzle.
 - Be sure to securely tighten the nozzle using two spanners when fitting the nozzle on the torch.
 - If the nozzle is tightened too firmly, it is heated up during cutting, which can further tighten it and make it difficult to remove.
 - Do not scratch the mounting taper of the nozzle. This will cause backfiring.

5.3.4 Installing the rails

1. Place the rails parallel to a scribed line, and check that they are parallel either by making the carriage travel along them by hand, or by using a jig. In addition, when considering the thermal effects on the rails, ideally the distance between the rails and the scribed line should be at least 100 mm.

5.4 Safety Measures before Starting Work

5.4.1 Grounding the ground wire

As a safety measure for the operator, first check that the appropriate supply voltage is input and that the cabtire cable is securely connected.

■ How to connect the ground wire

The rubber plug of the cab tire cable has a grounding pin. Use a power outlet with an opening to receive the ground pin.

5.4.2 Operating the direction selection switch

- The direction selection switch is used to switch between forward and reverse travel. The neutral position is to stop the unit.
- When switching the direction, always return the direction switch to “stop” (neutral position) and ensure the unit has stopped before switching the direction of the travel.
- Always leave the switch at “stop” (neutral position) except when you want the unit to travel.
- Set the direction switch to “stop” (neutral position) before turning the power on. If the power is turned on with the switch set to forward or reverse the unit will start traveling, which is dangerous.
- Never put your hands between the guide rollers or between the unit body and rails while the unit is traveling. Your hand may get trapped.

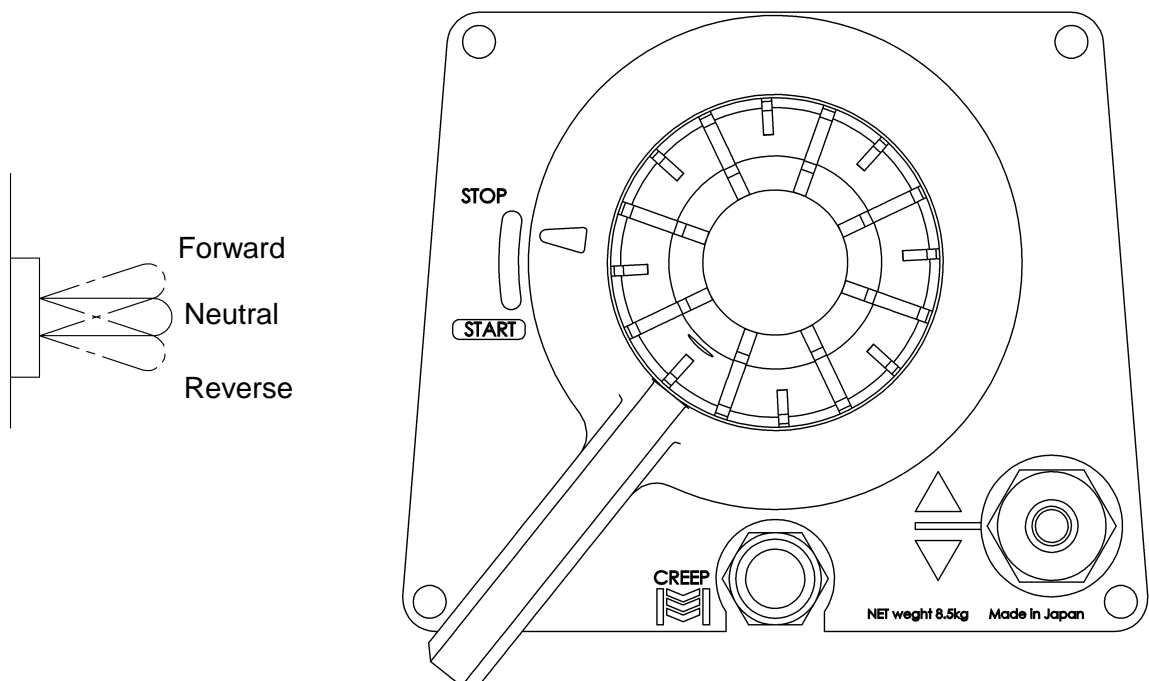

5.5 Ignition and flame adjustment

- Adjust the gas pressure according to the Cutting Data. The data shows the pressure when all the valves are open. Readjust the pressure after ignition.

■ Flame adjustment method

1. Open the fuel gas valve 1/4~1/2 a turn, and light the torch with an igniter.
2. Then, open the preheating oxygen valve gradually until a white cone of the standard flame has been obtained.
(THE incandescent area should be uniform and about 5-6 mm (3/16-1/14") in length.)
3. Open the jet oxygen valve fully. Readjust the flame if its condition has changed. A disorderly flow of the jet oxygen will adversely affect the quality of the cutting surface. In such a case, clean the tip with a suitable cleaning needle while the jet oxygen is flowing
4. Appropriate distance between the tip end and cutting surface.
 - Acetylene gas8-10mm
 - LPG gas5-8mm

5.6 Cutting and piercing method

1. Cut in from the end of steel plate.
2. Pierce steel plate before cutting.
3. Drill a hole before cutting.

■ Piercing method

- 1) Ignite and adjust the flame.
- 2) Thoroughly preheat the cut-in point until it is white hot.
- 3) Open the cutting oxygen valve to pierce the steel plate. The tip should be about 15-20 mm from the plate to prevent slag from splashing onto the tip and adhering there, which will shorten the working life of the tip.

5.7 Procedures for starting cutting operation and extinguishing the flame

1. Set Multi-function selector switch to SPEED①~③ and adjust to the cutting start position. Ignite it and adjust the flame.
2. Set the clutch in the START position to sufficiently heat the cutting start position.
3. After preheating, supply oxygen and simultaneously turn on the motor switch or the turning direction switch to start cutting.
4. Carefully check the cutting condition, and control the cutting speed with the speed adjuster. For the cutting speed, refer to the Cutting Data.
5. Extinguish the flame after cutting as follows:
 - 1) Turn off the motor switch (or turning direction switch).
 - 2) Close the cutting oxygen valve.
 - 3) Close the preheating oxygen valve.
 - 4) Close the fuel gas valve.

5.8 Safety measures against backfire and flashback



5.8.1 Prevention of backfire

Backfires may cause serious accidents or fires. Be careful to prevent such disaster.

When a backfire occurs, find the cause and inspect and maintain the machine correctly before using the machine again.

The following are causes of backfire:

- 1) Improper gas pressure adjustment.
- 2) Overheated tip.
- 3) slag clogged in tip.
- 4) damage to the tapered section of the tip or torch will cause backfire.



5.8.2 Prevention of flashback

Flashback could cause fire and break the machine. Should there be a hissing sound in the torch, quickly take the following

Action:

- 1) Close the preheating oxygen valve.
- 2) Close the fuel gas valve.
- 3) Close the cutting oxygen valve.

Should flashback occur, find the cause and take appropriate action before using the machine again.

5.9 Cutting operation

1. Place the tip along the marked cutting line.
2. Set Multi-function selector switch to SPEED①~③
3. Open the gas valve and slightly open the preheating oxygen valve, and then ignite the oxygen with an ignition lighter. Then fully open the gas valve and make the flame neutral by controlling the preheating oxygen.
4. Adjust the height of the tip as against the steel sheet. (2-3 mm from the tip of the white point)
5. Engage the clutch, and after sufficient preheating, open the oxygen valve and turn on the forward or backward switch simultaneously. Then cutting operation will begin.
6. When cutting begins, carefully observe the cutting condition to set the optimum cutting speed.
7. After cutting, close the cutting oxygen valve and turn off the switch. Then close the gas valve and preheating oxygen valve in this order, and return the clutch to the stop position.

[Note]

- Check that the flow of cutting oxygen is at the right angles to the steel sheet.
- For correct cutting, set the gas pressure according to the Cutting Data. Correct the gas pressure according to the actual cutting conditions.

5.9.1 Straight cutting

The use of a high-accuracy plate rail ensures correct straight cutting. Plate rails are of a connection type, and connection of several rails will permit straight cutting of objects of any length

5.9.2 In bevel cutting

In case of bevel cutting, tilt torch to the desired angle. Depending on the combination of tip, it is possible to cut as shown in the figure.

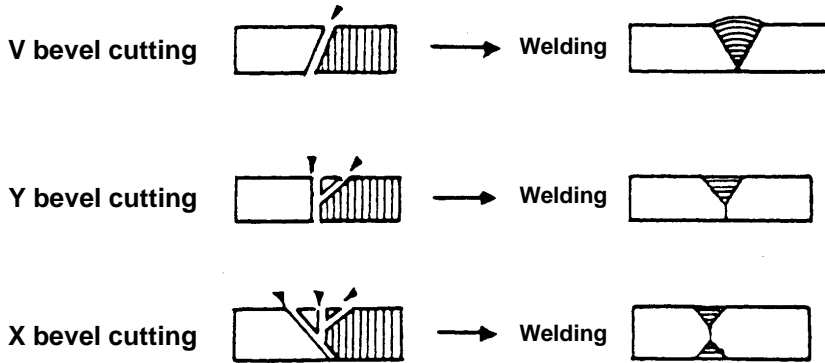

5.9.3 In circle cutting

The machine is set up differently in two configurations as shown in the photograph to the left. Set up for circle cutting is as follows.

■ For circle cutting attachment

1. Remove the shield plate, and free the idle wheel by removing the fixing washer.
2. Attach pivot pin and weight to radius bar. Please attach weight as close to the center as possible.
3. Free the guide wheel and pull the machine so that it describes a natural arc, and tighten the guide wheel in its natural position.
4. Cutting capacity $\phi 600 \sim \phi 2200$

■ For circle rail

1. Align the idle wheel to the inside groove of the track, and the guide wheel to the outside groove.
2. Free the guide wheel and tighten it in its natural position.
3. Cutting performance may be improved by forward travelling.
4. Cutting capacity $\phi 100 \sim \phi 360$ $\phi 770 \sim \phi 1150$

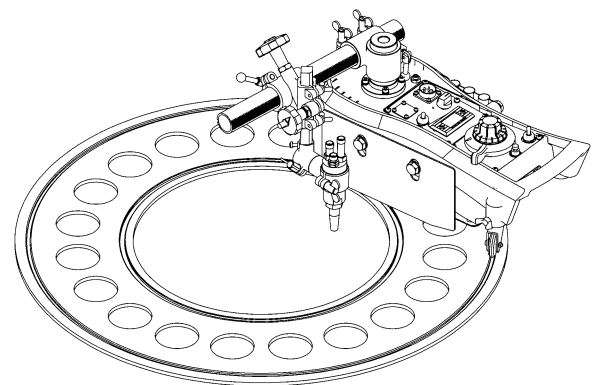
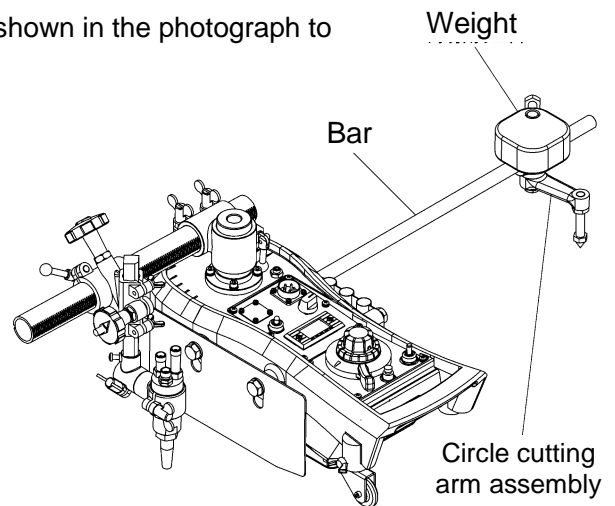

5.9.4 Gas cutting condition

1. The drag must be correct.
2. The cut surface must be sufficiently smooth and the drag groove must be shallow without notches
3. The upper edge of the cut surface must be sharp
4. Slag must be separated easily

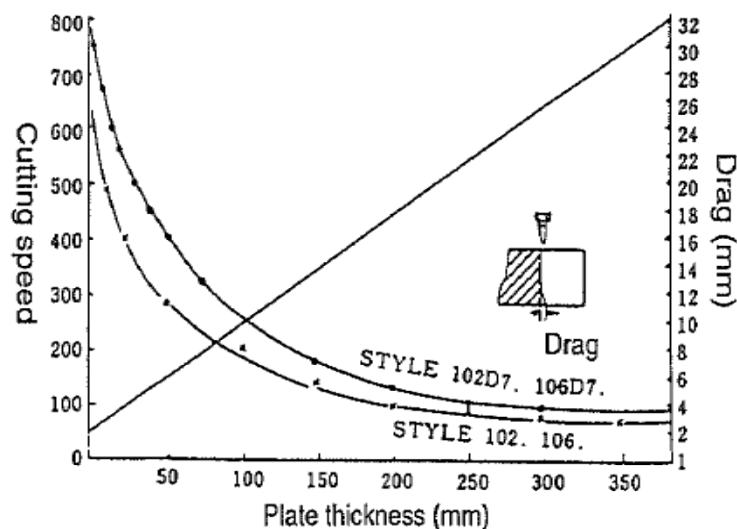

6 Plasma cutting operation

6.1 Preparation for Work

1. Attach the plasma torch holder to IK - 12 NEXT.
2. Connect the plasma power cable to the main unit.
3. Connect the cord side receptacle (plug) to the main unit side receptacle (receptacle). Before connecting, check that foreign matter, dust, etc. are not contained.
4. The plug is screwed type. Be sure to tighten the screws to prevent disengagement of the plug while running.
5. Please connect to each joint according to the instruction manual of plasma power supply.

6.2 Cutting operation

1. Please align the tip of the torch with the marking line you want to cut.
2. Set Multi-function selector switch to SPEED①~③.
3. When putting the clutch into START and tilting the direction change switch to forward or reverse, an arc occurs only when the arc changeover switch is ON. If the arc stabilization time is set, an arc will be generated while the carriage stops for the set time. After the set time elapses, the carriage starts to move.
4. Please observe the cut state carefully after starting cutting and adjust it to the optimum speed.
5. After cutting, please return the direction change switch to neutral. The arc and carriage will stop.

7 Welding Work

7.1 Preparation for Work

1. Attach welding holder to IK-12 NEXT.
2. Connect the welding power cable to the main unit.
3. Connect the cord side receptacle (plug) to the main unit side receptacle (receptacle). Before connecting, check that foreign matter, dust, etc. are not contained.
4. The plug is screwed type. Be sure to tighten the screws to prevent disengagement of the plug while running.
5. Please connect to each joint according to instruction manual of welding power supply.

7.2 Welding Work

1. Align the wire tip with the welding position.
2. Set the multi-function selector switch to any of the SPEED (1) to (3) positions.
3. The arc will be generated only while the arc selection switch is set to ON with the clutch at START and the direction selection switch is flipped to forward or reverse. If an arc stabilization time is set, the arc will be generated with the carriage stopped for the set time. After the set time has elapsed, the carriage will start moving.
4. When welding starts, observe the conditions carefully and adjust to the optimum cutting speed.
5. After the welding is finished, turn the direction selection switch back to neutral. Arc generation and the carriage will stop.

8 Maintenance Inspections

Disassemble the unit by following the procedure below.

1. Remove the heat insulating plate.
2. Remove the six screws in the operation panel.
3. Take the connecting bar off the pins.
4. Remove the four screws that secure the upper case and the lower case of the unit body.

It will now be possible to separate the upper and lower cases of the unit body.

Carry out the following maintenance and inspection work in order to be able to use this unit in the best condition at all times.

8.1 Daily Inspections

1. Wipe off the dirt on the unit with a clean cloth (especially the pipe arm key slots and rack parts).
2. Lubricate the axles of the casters.
3. Wipe the outer peripheries of the wheels and idlers with an oily cloth.

8.2 Monthly Inspections

1. Lubricate the clutch lever.
2. Measure the insulation resistance. (Measure the resistance between one terminal of the power outlet and the metal part of the case and check that it is at least 5 mW.)
3. Remove dust from the electrical components inside the unit.
4. Remove and clean the glass retainer of the speed display.













8.3 3-monthly Inspections (Every 2,000 Hours)

1. Separate the lower case and the gearbox, and, depending on the situation, thoroughly flush out the old grease in the gearbox with washing oil and apply new grease. (Obtain grease from our sales office.)
2. Replace internal parts with significant wear.

8.4 About the Warranty

We will make "repairs free of charge for one year" from the date of delivery only in the case of failures that are "attributable to the manufacturer", where the product has been subject to "normal conditions of use" in accordance with this operation manual. Note, however, that consumables are not covered by the warranty. (The specifications of this equipment and contents of this manual are subject to change without notice.)

9 Trouble shooting

Defects	Cause/check position				
(1) No electric power supply	<p>1) No power supply voltage to outlet 2) Cable is disconnected</p> <table border="1" data-bbox="624 405 1414 819"> <tr> <td data-bbox="624 405 879 506">  ARNING </td> <td data-bbox="879 405 1414 506">Kindly take care about following things to avoid getting an electric shock.</td> </tr> <tr> <td data-bbox="624 506 879 819">  </td> <td data-bbox="879 506 1414 819"> <ul style="list-style-type: none"> ● Since above mentioned 1) and 2) checking are to be carried out while control power supply is ON, professional engineer having enough knowledge and skill about electric handling should go to prevent risk of short circuit, getting an electric shock. </td> </tr> </table>	 ARNING	Kindly take care about following things to avoid getting an electric shock.		<ul style="list-style-type: none"> ● Since above mentioned 1) and 2) checking are to be carried out while control power supply is ON, professional engineer having enough knowledge and skill about electric handling should go to prevent risk of short circuit, getting an electric shock.
 ARNING	Kindly take care about following things to avoid getting an electric shock.				
	<ul style="list-style-type: none"> ● Since above mentioned 1) and 2) checking are to be carried out while control power supply is ON, professional engineer having enough knowledge and skill about electric handling should go to prevent risk of short circuit, getting an electric shock. 				
(2) Traveling speed of carriage is not changing	<table border="1" data-bbox="624 842 1414 1357"> <tr> <td data-bbox="624 842 879 943"> WARNING </td> <td data-bbox="879 842 1414 943">Kindly take care about following things to avoid getting an electric shock.</td> </tr> <tr> <td data-bbox="624 943 879 1357">   </td> <td data-bbox="879 943 1414 1357"> <ul style="list-style-type: none"> ● Kindly carry out continuity check by tester while electric supply is turned OFF. ● Since above mentioned 2) and 3) checking are to be carried out while control power supply is ON, professional engineer having enough knowledge and skill about electric handling should go to prevent risk of short circuit, getting an electric shock. </td> </tr> </table> <p>1) Defective motor 2) Defective printed board 3) Disconnection of motor encoder line</p>	WARNING	Kindly take care about following things to avoid getting an electric shock.	 	<ul style="list-style-type: none"> ● Kindly carry out continuity check by tester while electric supply is turned OFF. ● Since above mentioned 2) and 3) checking are to be carried out while control power supply is ON, professional engineer having enough knowledge and skill about electric handling should go to prevent risk of short circuit, getting an electric shock.
WARNING	Kindly take care about following things to avoid getting an electric shock.				
 	<ul style="list-style-type: none"> ● Kindly carry out continuity check by tester while electric supply is turned OFF. ● Since above mentioned 2) and 3) checking are to be carried out while control power supply is ON, professional engineer having enough knowledge and skill about electric handling should go to prevent risk of short circuit, getting an electric shock. 				
(3) Flipping direction selection switch while stopped will not output an arc signal and will not run.	<p>1) Defective direction selector switch 2) Defective printed board 3) Disconnection of short circuit connector</p>				
(4) Flipping direction selection switch while it is stopped will output an arc signal, but will not run.	<p>1) Defective printed board 2) Disconnection of motor (disconnection of DC line or disconnection of both DC line and encoder line)</p>				

<p>(5) Flipping direction selection switch while stopped will not output an arc signal and will run.</p>	<p>1) ARC OFF option is selected in Arc mode changing over switch. 2) No welding current. 3) Metal outlet for torch switch is not connected. 4) Kindly verify whether there is short circuit between ①-② metal outlet pin <ul style="list-style-type: none"> · In case of short circuit, welding current is defective · In case of no short circuit, there must be disconnection of cable , defective printed board </p>
<p>(6) Even if direction selection switch is returned to neutral while running, the running of the carriage and the output of the arc signal do not stop.</p>	<p>1) Defective direction selector switch 2) Defective printed board</p>
<p>(7) Carriage travel stops, but arc signal output fails to stop, when the direction selection switch is returned to neutral during travel.</p>	<p>1) The crater filling (self-latching) ON/OFF setting does not agree with that at the welding (plasma) power source and the carriage. 2) Printed circuit board failure</p>
<p>(8) Output of the arc signal stops, but carriage travel fails to stop, when the direction selection switch is returned to neutral during travel.</p>	<p>1) Printed circuit board failure</p>
<p>(9) The travel speed of the carriage does not change when the CREEP button is pressed.</p>	<p>1) Printed circuit board failure 2) Creep button failure 3) Wire disconnection</p>
<p>(9) The digital meter display does not change when the multi-function selector switch setting is changed.</p>	<p>1) Printed circuit board failure 2) Wire disconnection</p>
<p>(12) The parameter value does not change when the volume switch is turned.</p>	<p>1) Printed circuit board failure 2) Wire disconnection</p>
<p>13) The arc is interrupted and the operation of the carriage and welding become abnormal while the carriage is traveling with self-latching ON.</p>	<p>1) When the crater filling (self-latching) ON/OFF setting is ON there is no function for synchronization with the welding power source, so when the arc is interrupted during welding operation there may be a mismatch between the operation of the carriage and the welding operation. * When the arc is interrupted and carriage travel is stopped, discrepancies between the welding current and carriage operation can be prevented by turning the welding power source off and back on again.</p>

(14) Clutch malfunction	<ol style="list-style-type: none">1) Connecting bar and lever pins not connected2) Failure of the spring / ball plunger (loose)3) Failure of the clutch wheel / worm wheel4) Clutch wheel and the axle lubrication shortage
(15) High level of vibration or noise	<ol style="list-style-type: none">1) Foreign object trapped in the gears2) Wear of gears3) Motor failure4) Speed reducer failure
(16) Knocking occurs	<ol style="list-style-type: none">1) Gear wear2) Play between the axle and wheels3) Foreign objects or damage on rail grooves4) Hoses and cables interfering with travel5) Failure of the casters6) Damage to, or adhesion of foreign matter to, a wheel or idler

10 Wiring diagram

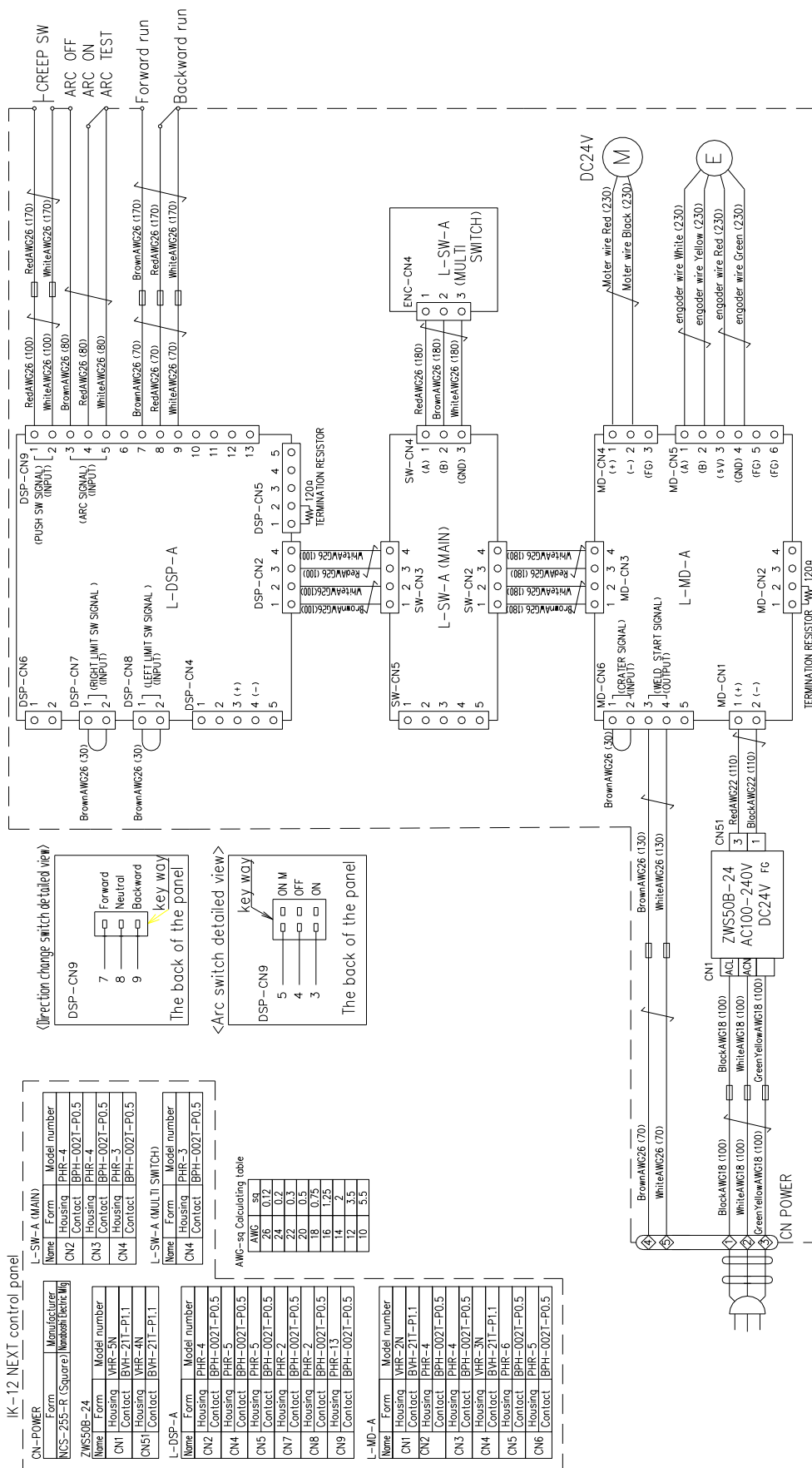

11 Assembly drawing of IK-12 NEXT

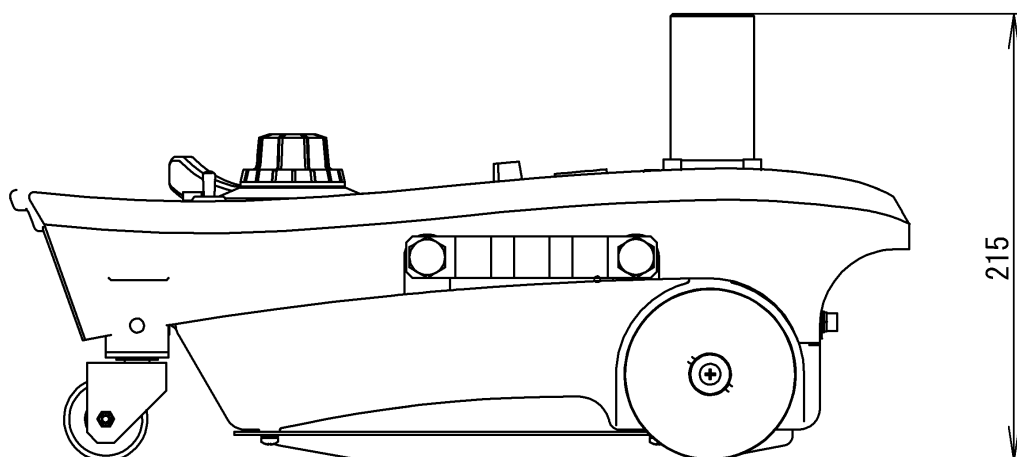
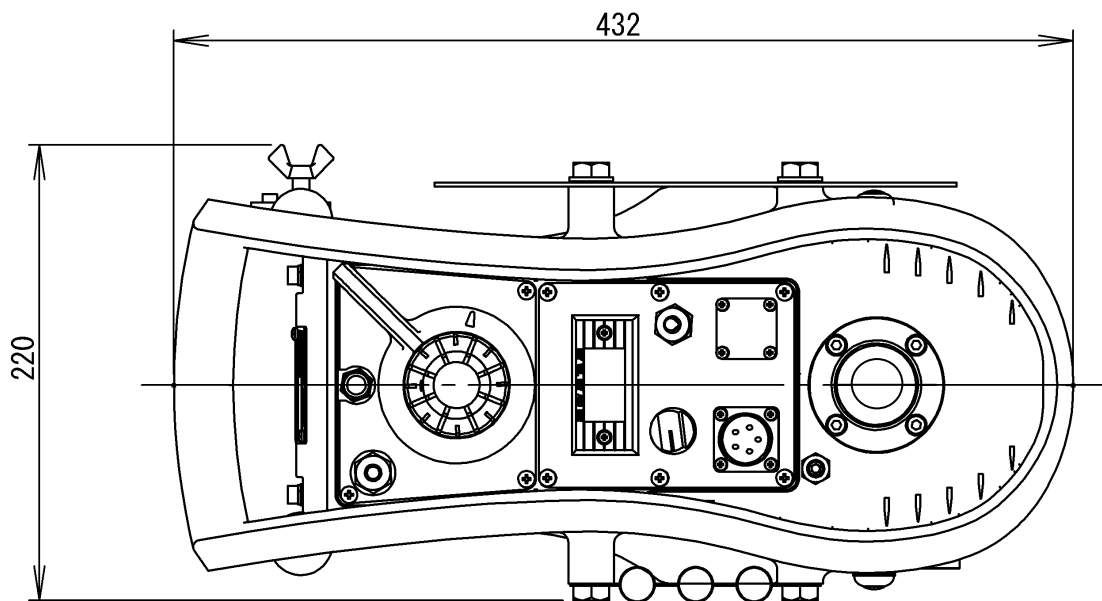

215mm=8.465inch
220mm=8.661inch
432mm=17.008inch

12 Parts list

12.1 Main body and inside parts

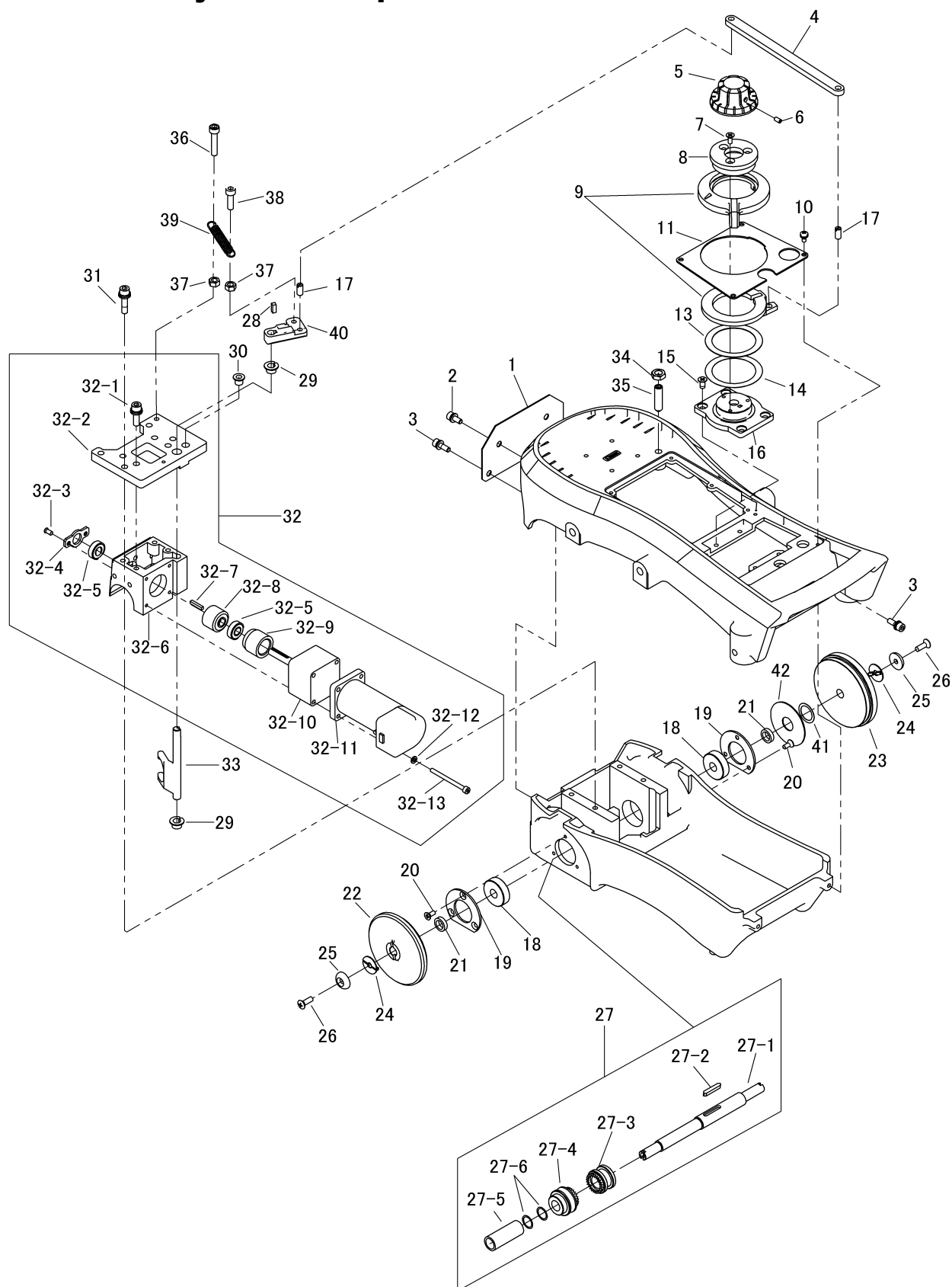

Main body and inside parts

ITEM No.	PART NAME	QTY	STOCK No	REMARKS	ITEM No.	PART NAME	QTY	STOCK No	REMARKS
1	Cover	1	20506249		30	DU bush	1	6D710607	MB0607-12FDU
2	Hexagon socket head cap screw	2	6C450510	BC-5x10(WS,WF)	31	Hexagon socket head cap screw	4	6C450625	BC-6x25(WS,WF)
3	Hexagon socket head cap screw	4	6C450512	BC-5x15(WS,WF)	32	Gear box assembly	1	20506421	
4	Connecting bar	1	20506222		32-1	Hexagon socket head cap screw	4	6C450625	BC-6x20(WS,WF)
5	Speed dial	1	20506236		32-2	Gear box cover	1	20506229	
6	Hexagon socket setscrew	1	6C560408	SSS-4x8	32-3	Screw	2	20504669-Y	M4x8
7	Screw	3	6C500408	SF-4x8	32-4	Gear box bearing plate	1	20503579	
8	Clutch support	1	20506244		32-5	Bearing	2	6A030698	
9	Clutch lever assembly	1	20507111		32-6	Gear box	1	20503565	
10	Screw	4	6C570408	M4x8(WS,WF)	32-7	Key	1	20503768	
11	Speed plate	1	20506227		32-8	Worm gear	1	61007941	
13	Clutch lever shim (0.2)	(1)	20506670		32-9	Gear box bearing spacer	1	20503575	
14	Clutch lever shim (0.5)	(1)	20506245		32-10	Gear head	1	61007942	IG-43-KS5 1/49
15	Screw	4	6C500510	SF-5x12	32-11	Motor	1	61007939	With the pinion
16	Clutch lever base	1	20506242		32-12	Spring washer	4	6D510040	WS-4
17	Lever pin	2	60032325		32-13	Hexagon socket head cap screw	4	6C030450	BC-4x50
18	Bearing	2	6A036200	6200ZZ	33	Clutch shaft	1	20506220	
19	Bearing plate	2	20503582		34	Nut	1	6D030080	NH-8
20	Screw	6	6C500410	SF-4x10	35	Ball plunger	1	20506237	BST8AL
21	Wheels spacer	2	20506246		36	Hexagon socket head cap screw	1	6C030630	BC-6x30
22	Idler wheel	1	60030244		37	Nut	2	6D030060	NH-6
23	Drive wheel	1	60030243		38	Hexagon socket head cap screw	1	6C030620	BC-6x20
24	Fixed washer	2	60030242		39	Spring	1	20506261	
25	Round washer	2	60030241		40	Connecting bar B	1	20506224	
26	Screw	2	6C510515	SM-5x15	41	Wave shape washer	1	20509327-Y	W-16
27	Drive shaft assembly	1	20506422		42	Metal washer	1	20509328	
27-1	Drive shaft	1	20506221						
27-2	Key for drive shaft	1	20506262						
27-3	Clutch wheel	1	20506225						
27-4	Worm wheel	1	20506232						
27-5	Worm wheel spacer	1	20506228						
27-6	Wave shape washer	2	20509332	PACK-WVWS-V12-D15					
28	Key	1	20506247	4x4x10L					
29	DU bush	2	60038164	MB0806-15FDU					

12.2 Outside parts

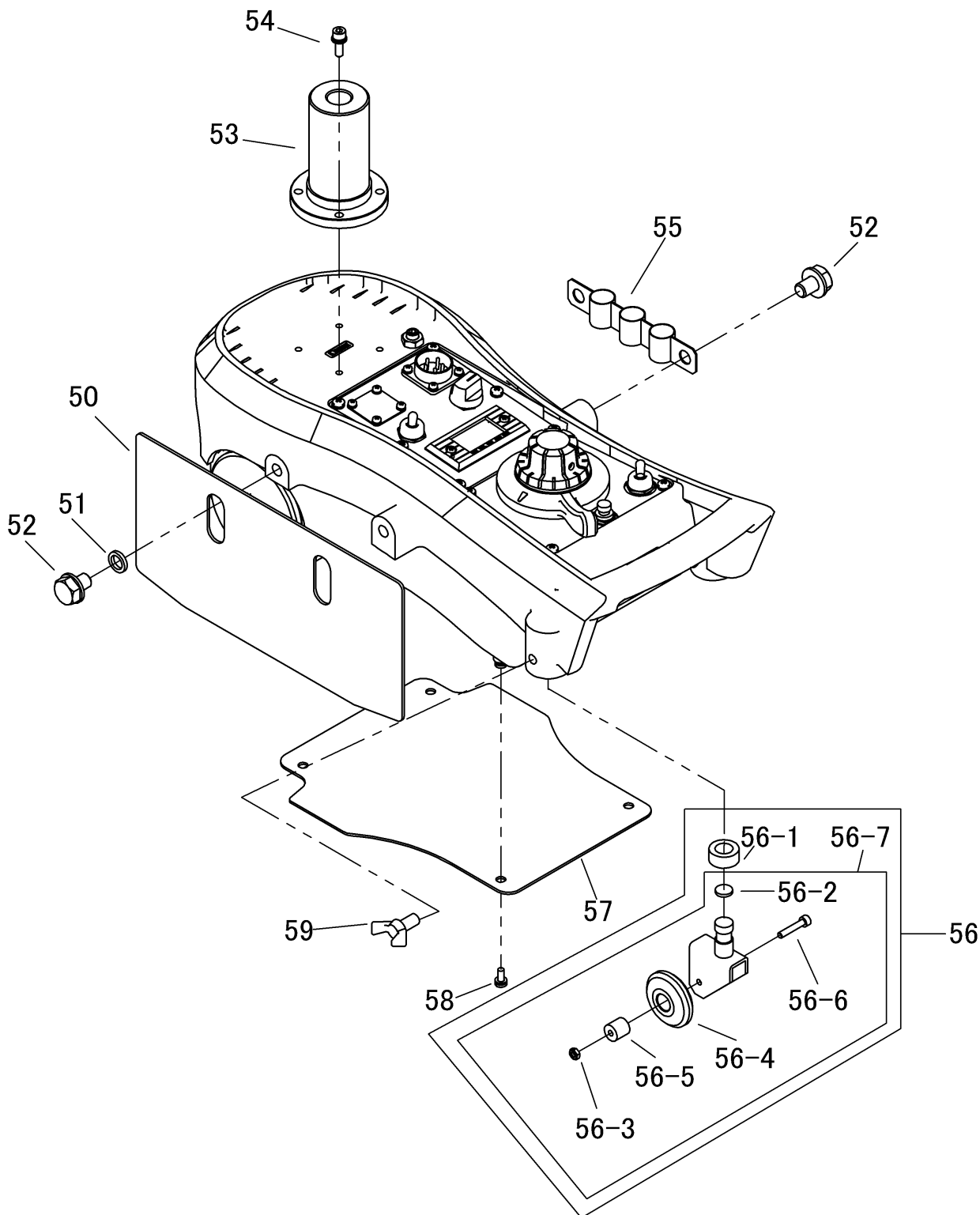

Outside parts

ITEM No.	PART NAME	QTY	STOCK No	REMARKS	ITEM No.	PART NAME	QTY	STOCK No	REMARKS
50	Heat insulating plate	1	20506234						
51	Heat insulating plate spacer	2	20506334						
52	Hexagon socket head cap screw	4	6C411020	BH-10x20(WF)					
53	Stand	1	60030204						
54	Hexagon socket head cap screw	4	6C450515	BC-5x15(WS,WF)					
55	Chip support assembly	1	60035003	Accessories					
56	Universal wheel assembly	1	20506418						
56-1	Spacer	1	20506235						
56-2	Washer	1	60030211						
56-3	U nut	1	6D400003	M4					
56-4	Roller	1	60030213						
56-5	Universal wheel spacer	1	60039352						
56-6	Hexagon socket head cap screw	1	6C030422	BC-4x22					
56-7	Universal wheel assembly	1	60039350						
57	Undercover	1	20506226						
58	Screw	4	6C570410	SP-4x10 (WS,WF)					
59	Wing nut	1	6C120815	8x15					

12.3 Electrical parts

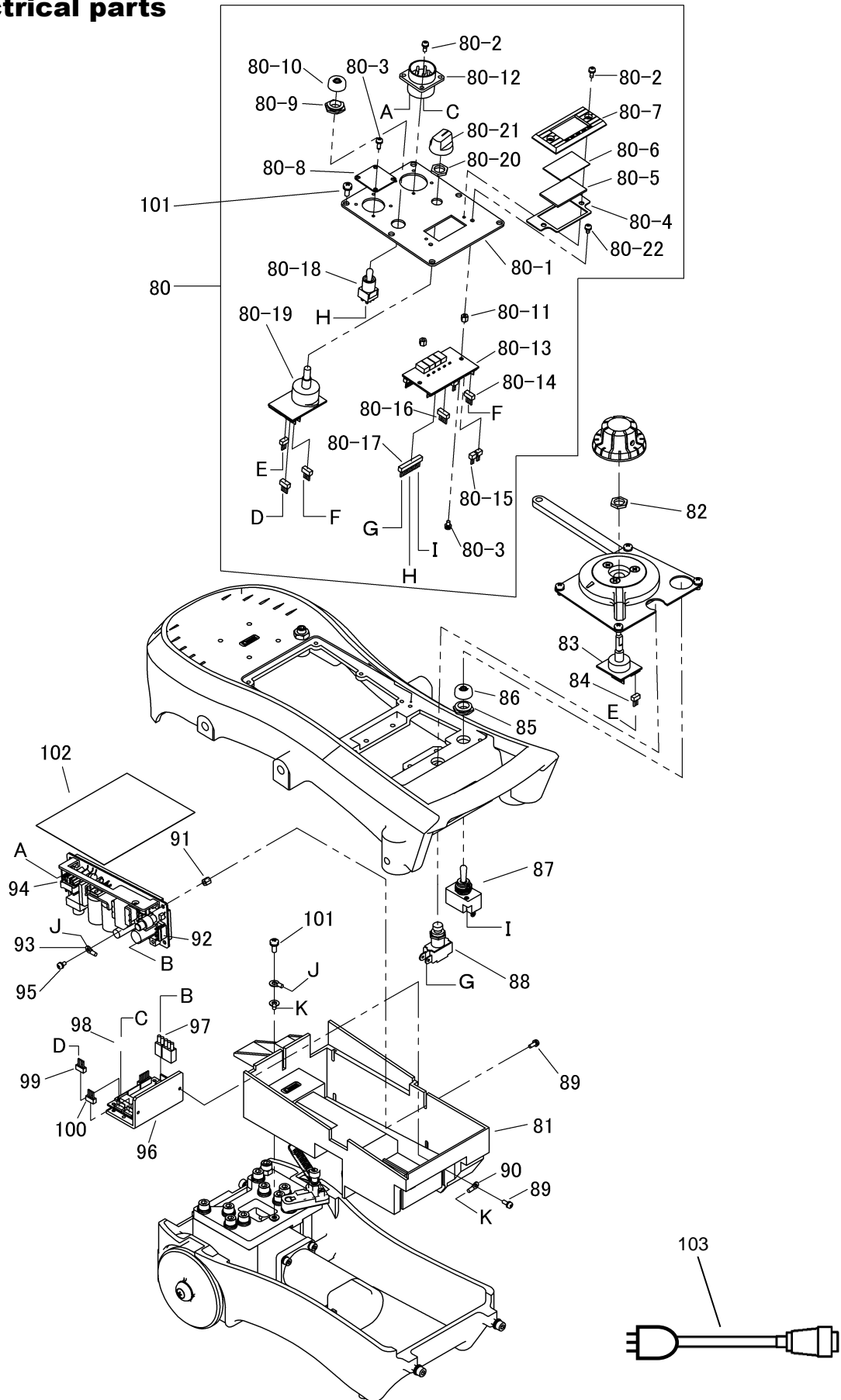

Electrical parts

ITEM No.	PART NAME	QTY	STPCK No	REMARKS	ITEM No.	PART NAME	QTY	STOCK No	REMARKS
80	Operation board assembly	1	20506436		88	Push button switch assembly	1	20506474	~ switch harness plaiting
80-1	Operation name plate	1	20507065			Push button switch	1	60036249	SB-221
80-2	Screw	10	6C570308	SP-3x8(WS,WF)	89	Screw	5	6C570308	SP-3x8(WS,WF)
80-3	Screw	2	6C570305	SP-3x5(WS,WF)	90	Ground wire plaiting B	1	20506532	
80-4	Panel spacer	1	20506239		91	Spacer	4	20506525	ASB-306E
80-5	Acrylic plate	1	20503617		92	Power supply	1	64000511	ZWS50B-24/CO2
80-6	Glass	1	20503619		93	Ground wire plaiting A	1	20506531	
80-7	Glass support	1	20503588		94	Harness plaiting A	1	20506483	CN1~ Receptacle assembly
80-8	Operation plate cover	1	20506313		95	Screw	5	6C570306	SP-3x6(WS,WF)
80-9	Dustproof nut	1	60032480		96	L-MD-A substrate	1	20508809	★
80-10	Waterproof cap	1	60032431		97	Harness plaiting B	1	20506482	CN51~ MD-CN1
80-11	Spacer	2	60036469	SP-5	98	Harness plaiting C	1	20506481	MD-CN6~ Receptacle assembly
80-12	Receptacle assembly	1	20506464	~Harness plaiting A ~Harness plaiting C	99	Harness plaiting D(4P ~4P)	1	20506478	MD-CN3~ SW-CN2
	Receptacle	1	64000510	NCS-255-R(square)	100	Terminating resistance assembly 4P	1	61006519	MD-CN2
80-13	L-DSP-A substrate	1	20508806	★	101	Screw	7	6C570410	SP-4x10(WS,WF)
80-14	Harness plaiting(4P~4P)	1	20506476	DSP-CN2~ SW-CN3	102	Polycarbonate plate	1	20507153	0.25tx90Wx120L
80-15	Short circuit connector	1	20506479	DSP-CN7	103	Power cable	1	20506329	★
	Short circuit connector	1	20506479	DSP-CN8					
80-16	Terminating resistance assembly 5P	1	61006520	DSP-CN5					
80-17	Switch harness plaiting	1	20506470	DSP-CN9 With arc selector switch					
80-18	Arc selector switch	(1)	6N110009						
80-19	L-SW-A(MAIN) substrate	1	20508811	★					
80-20	Nut (54D)	1	6D400001						
80-21	Knob	1	61005744	K-90-S					
80-22	Screw	2	6C570306	SP-3x6(WS,WF)					
81	e-box	1	20506231						
82	Nut(54D)	1	6D400001						
83	L-SW-A(MULTISWITCH) substrate	1	61006244						
84	Harness plaiting E (3P~3P)	1	20506477	SW-CN4~ ENC-CN4					
85	Dustproof nut	1	60032480						
86	Water proof cap	1	60032431						
87	Direction selector switch assembly	1	20506475	~ switch harness plaiting					
	Direction selector switch	1	20506230	S-3A					

13 Cutting Data

Cutting hole diameter (mm)

TIP SIZE TYPE	00	0	1	2	3	4	5	6	7	8
STANDARD	0.8	1.0	1.2	1.4	1.6	1.9	2.3	2.7	3.0	3.4
D5 type		0.8	1.0	1.2	1.4	1.6	1.8	2.1		
D7 type		0.6	0.9	1.1	1.3	1.5	1.8	2.1	2.6	3.2

102(STANDARD SPEED) For Acetylene

PLATE THICKNESS (mm)	TIP SIZE	CUTTING SPEED (mm/min)	PRESSURE (kg/c m ²) / (Mpa)		FLOW RATE L/H		
			OXYGEN	ACETYLENE	CUTTING OXYGEN	PREHEATING OXYGEN	ACETYLENE
3~5	00	700~660	1.5 / 0.15	0.2 / 0.02	690	410	370
5~10	0	660~550	2.0 / 0.2	0.2 / 0.02	1,200	410	370
10~15	1	550~490	2.5 / 0.2	0.2 / 0.02	2,100	480	430
15~30	2	490~400	3.0 / 0.25	0.2 / 0.02	3,400	480	430
30~40	3	400~350	3.0 / 0.3	0.2 / 0.02	4,300	480	430
40~50	4	350~320	3.5 / 0.35	0.25 / 0.025	6,500	550	500

102-D5 type (Acetylene)

PLATE THICKNESS (mm)	TIP SIZE	CUTTING SPEED (mm/min)	PRESSURE (kg/c m ²) / (Mpa)		FLOW RATE L/H		
			OXYGEN	ACETYLENE	CUTTING OXYGEN	PREHEATING OXYGEN	ACETYLENE
5~10	0	700~625	5.0 / 0.5	0.2 / 0.02	1,600	520	470
10~15	1	625~550			2,400	600	550
15~30	2	550~475			3,600	600	550
30~40	3	475~425			4,800	600	550
40~50	4	425~350			5,600	750	680

102-D7(HIGH SPEED) For Acetylene

PLATE THICKNESS (mm)	TIP SIZE	CUTTING SPEED (mm/min)	PRESSURE (kg/c m ²) / (Mpa)		FLOW RATE L/H		
			OXYGEN	ACETYLENE	CUTTING OXYGEN	PREHEATING OXYGEN	ACETYLENE
5~10	0	750~680	7.0 / 0.7	0.2 / 0.02	1,100	520	470
10~15	1	680~600			2,500	600	550
15~30	2	600~500			3,800	600	550
30~40	3	500~450			5,400	600	550
40~50	4	450~400			7,300	750	680

106(STANDARD SPEED) For Propane

PLATE THICKNESS (mm)	CHIP SIZE	CUTTING SPEED (mm/min)	PRESSURE (kg/c m ²) / (Mpa)		FLOW RATE L/H		
			OXYGEN	PROPANE	CUTTING OXYGEN	PREHEATING OXYGEN	PROPANE
3~5	00	700~660	1.5 / 0.15	0.2 / 0.02	690	1,180	310
5~10	0	660~550	2.0 / 0.2	0.2 / 0.02	1,200	1,180	310
10~15	1	550~490	2.5 / 0.2	0.2 / 0.02	2,100	1,180	310
15~30	2	490~400	3.0 / 0.25	0.25 / 0.025	3,400	1,370	360
30~40	3	400~350	3.0 / 0.3	0.25 / 0.025	4,300	1,370	360
40~50	4	350~320	3.5 / 0.35	0.3 / 0.03	6,500	1,860	490

106-D5 type (Propane)

PLATE THICKNESS (mm)	CHIP SIZE	CUTTING SPEED (mm/min)	PRESSURE (kg/c m ²) / (Mpa)		FLOW RATE L/H		
			OXYGEN	PROPANE	CUTTING OXYGEN	PREHEATING OXYGEN	PROPANE
5~10	0	700~625	5.0 / 0.5	0.2 / 0.02	1,600	1,180	310
10~15	1	625~550		0.2 / 0.02	2,400	1,180	310
15~30	2	550~475		0.25 / 0.025	3,600	1,370	360
30~40	3	475~425		0.25 / 0.025	4,800	1,370	360
40~50	4	425~350		0.3 / 0.03	5,600	1,860	490

106-D7(HIGH SPEED) For Propane

PLATE THICKNESS (mm)	CHIP SIZE	CUTTING SPEED (mm/min)	PRESSURE (kg/c m ²) / (Mpa)		FLOW RATE L/H		
			OXYGEN	PROPANE	CUTTING OXYGEN	PREHEATING OXYGEN	PROPANE
5~10	0	750~680	7.0 / 0.7	0.2 / 0.02	1,100	1,180	310
10~15	1	680~600		0.2 / 0.02	2,500	1,180	310
15~30	2	600~500		0.25 / 0.025	3,800	1,370	360
30~40	3	500~450		0.25 / 0.025	5,400	1,370	360
40~50	4	450~400		0.3 / 0.03	7,300	1,860	490

NOTE

- 1) All pressures are torch inlet pressures.
- 2) Oxygen purity is minimum of 99.7%, propane is minimum of JIS Grade 3.
- 3) Depending on the surface condition of the steel plate (scale, paint) either increase the fuel gas pressure or decrease the cutting speed. Also, when precision cutting is required, adjust all data.

IK-12 NEXT OPERATION MANUAL

Date of issue :	Sep.2018
2nd:	Nov.2018
3rd:	Dec.2018

KOIKE SANZO KOGYO CO.,LTD

Printed in Japan