

# WEL-HANDY MULTI NEXT™

## Compact Welding Carriage for Semi-Automated Welding

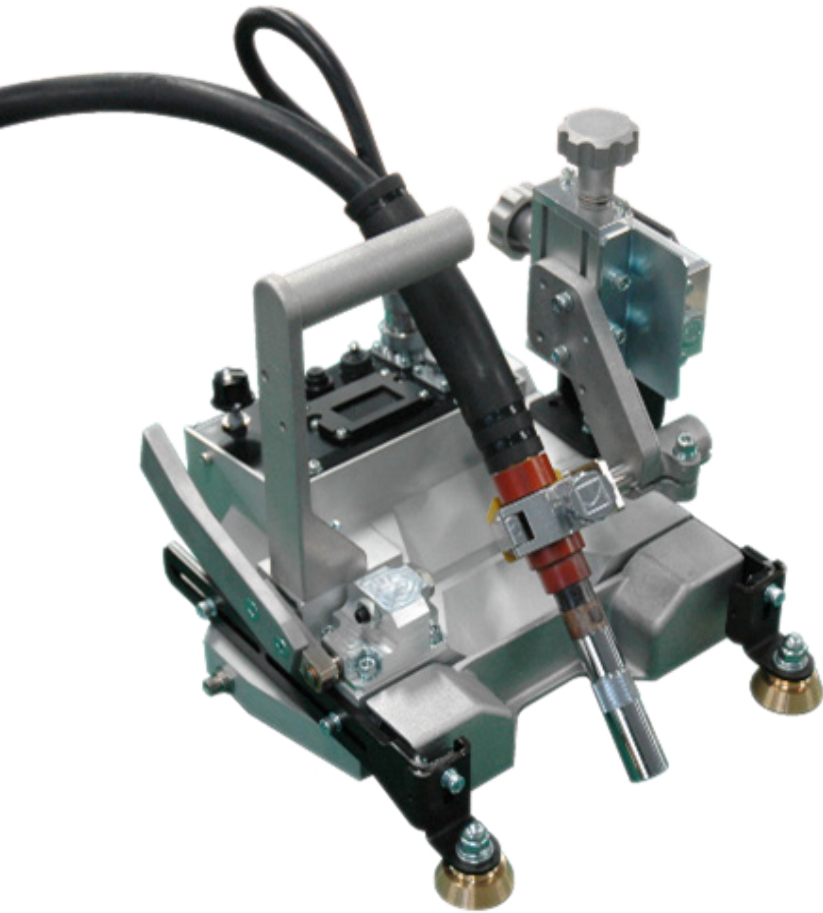

**Revolutionary new drive system.  
Compatible with all NEXT series machines.**

Wel-Handy Multi Next is a high performance welding carriage built to achieve highly repeatable results. WEL-HANDY MULTI NEXT is better built with advanced technology and versatility. Easy to operate and set up with no guide rails required.

### Features & Benefits

- **Multi-position guide rollers**  
Ensure proper alignment with work piece
- **Perform straight line, stitch and weave type welds with the same carriage**
- **Strong enough for overhead applications**
- **Built-in interface to welder.**
- **Does not require additional cabling for weaver**
- **Machine will pause and perform a back step while welding.**  
Ensures exact wire deposition throughout the weld
- **Enhanced limit switch features.**  
Stops the machine at the end of each weld but doubles as a jog to position with a single press of the switch
- **Encoder drive motor and control**
- **Multiple torch mounting configurations.**
- **Optional weaving unit (plug and play)**

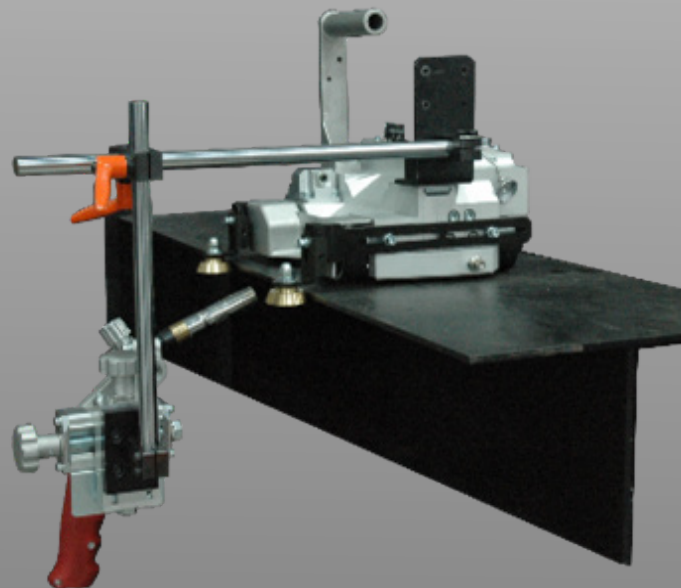

Model Description		Wel-Handy Multi NEXT
Part Number	K20503814	
Magnet type	Neodymium rare earth magnet applies up to 120 lbs of adhesion strength depending on saturation. ¼ in. plate minimum 110 lb (50kg)	
Driving system	Four wheel drive rubber tires, motor encoder with planetary gearbox	
Traction	4-wheel drive, solid rubber tires	
Ground clearance	⅞ in (5.5mm)	
Magnet Engagement	Side mounted mechanical lift off actuation	
Travel speed	2-60 in/min (50-1500mm/min)	
Arc stabilization time (sec)	0-10.0	
Guide type	Mechanical force utilizing brass guide wheels	
Types of welds	Fillet, V-Groove, Overhead, Out of Position, Submerged Arc, Dual Torch	
Welding interface	Utilizes power cord to send input signal to welder automatically	
Limit switch	Allows for automatic stop and jog to position	
Arc test	Momentary switch- ensures machine connectivity	
Crater fill with back-step	Programmable time, distance and speed to ensure adequate weld size	
Stitch	Momentary, On/Off Set by distance	
Weaving	Weaving speed	15.7-59 in/min (400-1500 mm/min)
	Weaving width (mm)	0-3.9 in (0-100 mm)
	Stop time on Left, Middle, Right	0-10
Body weight	19.4 lb (8.8kg)	
External dimensions Width x Depth x Height	11x11x9.8 in (280x280x250 mm)	
Input power supply	Single-phase AC100-240V 50Hz/60Hz	

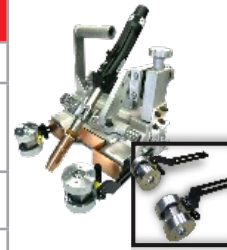

**Magnetic Guide Wheels**  
**Part# K115976301**  
 Commonly used to follow an uneven gusset or a flange in the workpiece.



**Weaver Unit WU-3R**  
**Part# 1148081500**  
**Compact, low profile weave system that bolts directly to the machine. Does not require any additional cabling to operate or interface. Has adjustable weave length and frequency to accommodate most applications.**



**Miller Adaptor**  
**Part#0868583600**  
 Used to adapt standard Wel-Handy interface plug to Miller equipment (Lincoln interface standard)

## Options

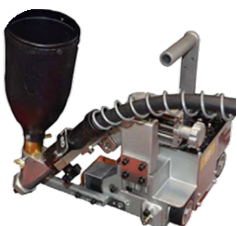

### Sub-arc Torch Kit Part#WHMSUBL15 (Lincoln) | Part#WHMSUBM15 (Miller)

Several options are available for sub-arc use with wire sizes ranging from 1/16 to 3/32 inch. Applications that previously may have been unachievable using larger and heavier mechanized system can now be accomplished with this compact sub arc welding option. The Sub Arc Torch Option can be used together with the Corner Welding Kit.





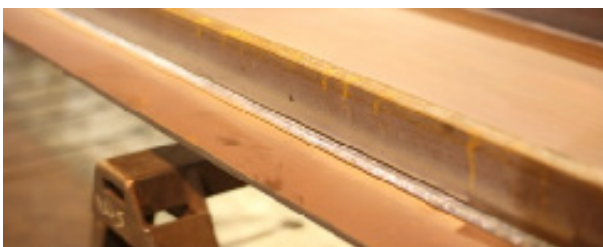





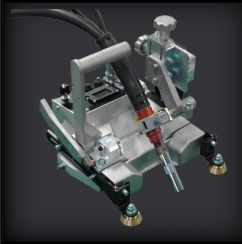

## Designed and built for extreme work conditions

- Designed with the help of our certified in-house welders.**  
 The Wel-Handy was developed to accomplish several different processes, as well as, being easy to operate. Ease of operation being the first and most influencing factor.
- Easy setup**  
 No guide rails required. The Wel-Handy drives into the fillet plate while placing consistent pressure into the root for accurate welds every time.
- TACK welding is now standard**  
 The new multi function controller allows operators to switch from continuous welding to stitch welding with a simple turn of the function dial.
- Excellent durability**  
 Maintenance free, single piece aluminium die cast body protected by copper heat shields. Resists slag penetration due to their normal cooling traits.
- 110 lb permanent magnet**  
 Ensures strong pulling power during horizontal and vertical welding. The magnet can easily be detached from the plate by a lever.
- Low Center of gravity**  
 Provides stable performance even while climbing a vertical surface.
- Durable roller and arm**  
 Guide rollers are made of brass and are mounted to a single-piece of carbon steel for higher durability. Roller is protected against spatter due to its cooling traits.
- Heat resistant rubber drive wheels**  
 Specialized rubber composition provides good grip while reducing the need for replacement due to premature wear.
- Sealed non-ferrous casting**  
 Die-cast body with stainless steel bottom plate ensures all drive mechanisms are completely sealed from heat and elements commonly found in the welding environment.



Perform consistent welds every time no matter what your experience is. With constant tip to work distance being automatically configured by the machine; the only thing to monitor is your wire feed rate and your carriage speed.

- 4-Wheel drive system**  
 Provides consistent traction and transmits the power to the plate efficiently.
- Dust proof electrical switches**  
 Reduces the impact of dust and other contaminants from entering costly electrical components.
- Limit switches at each end of the carriage**  
 Automatic shutdown at the end of the weld. Limit switches can be used to adjust machine starting position by pressing in the direction you would like to travel.
- Tack Counting**  
 Can input the number of tacks to perform and the machine will stop

Wel-Handy Series Application Guide			
Type of Application		Wel-Handy Mini Strong Part# 61007281	Wel-Handy Multi Next Part# 20503814
Fillet Weld 		x	x
Butt Weld 		x	x
Stitch 		-	x
Vertical Weld 		x	x
Horizontal Position 		x	x
Overhead Position 		-	x
Out of Position 	Add Comer Kit + Guide Roller Extension	Add Comer Kit + Guide Roller Extension	
Contour Weld 	Add Magnetic Wheel Kit	Add + Follower Kit or Magnetic Wheel Kit	
Oscillation 		-	Add + WU-5R Weaver
Dual Pass 		-	Add + Twin Torch
Overhanging Weld 		x	x
Sub-Arc 		-	Add + Miller Subarc Kit or Large torch holder

- 1 Digital LED Display**  
Allows accurate and precise parameter input. Allows each welder to use the same parameters regardless of experience. Visible in low light conditions.

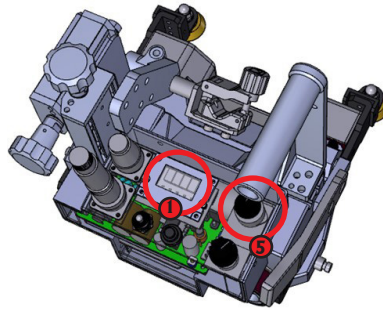

- 2 Detachable carrying handle**  
Used to lift machine. Doubles as a support to control the welding lead.

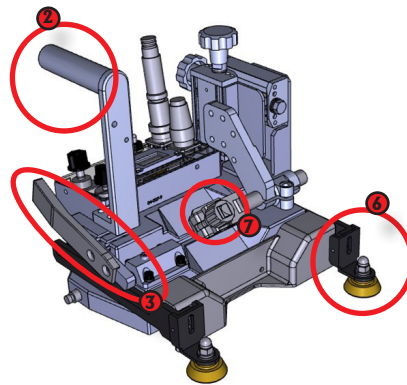

- 3 Mechanical magnet lift off**  
Utilizes mechanical force to reduce pry-off torque needed to separate the magnet from the workpiece. Has 3 positions; On (completely saturated)/ Off (no magnetic force applied)/ Partial saturation (used to hold machine around a vessel).

- 4 Brass guide rollers**  
Used to guide the machine along a fillet plate. Brass composition reduces heat effect and spatter build up due to its natural cooling traits.

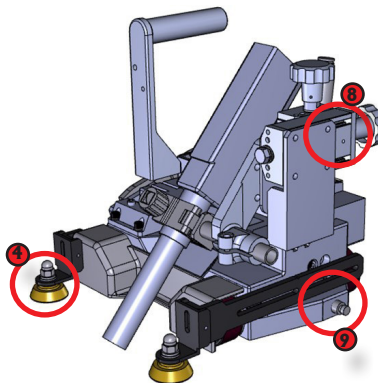

- 5 Rotary data dial**  
Main component used to set parameters. Developed by certified in-house welders to be completely transparent for data input. Reduces time and research needed to setup proper machine control.

- 6 Guide Rollers**  
Multi use position guide rollers allow for more flexibility than common types. Rollers can be flipped, dropped or spun into various positions in front of the machine or behind. Designed to work around obstacles in a fillet plate. Rollers can be used as a box and beam guide when placed into the negative position. Will move 1" below the base of the machine.

- 7 Quick release torch clamp**  
Allows for a wide range of torches. Diameter size ranges from .5" to 1.5". Has extra heavy ribs on tension knob to allow for extreme torque with gloved hands.

- 8 Smooth action cross slide**  
Allows for 2" of movement in either axis. A smooth action ball screw is used to reduce imperfections when changing weld height and distance. Heavy ribbed knobs allow for extreme torque with gloved hands.

- 9 Limit Switch**  
Located at either end of machine. Used to turn off the tractor and welding power supply simultaneously. Includes "jog to point technology;" simply press the limit in the direction of desired travel and the machine will move to your starting position.